



सत्यमेव जयते



भारत सरकार Government of India

विद्युत मंत्रालय Ministry of Power

उत्तर पूर्वी क्षेत्रीय विद्युत समिति

North Eastern Regional Power Committee

एन ई आर पी सी कॉम्प्लेक्स, डोंग पारमाओ, लापालाङ, शिल्लोंग-७९३००६, मेघालय

NERPC Complex, Dong Parmaw, Lapalang, Shillong - 793006, Meghalaya

SPEED POST/FAX

Ph : 0364-2534039

Fax: 0364-2534040

email: nerpc@ymail.com

website: www.nerpc.gov.in

No.: NERPC/SE(O)/2023/

June 07, 2023

To

As per list attached.

Sub: Minutes of the 25th NeTEST Coordination Committee Meeting -reg.

Sir/Madam,

Please find enclosed herewith the minutes of the 25th NETeST Meeting held on 25th May, 2023 at "NERPC Conference Hall" NERPC Complex, Lapalang, Shillong for your kind information and necessary action. The minute is also available on the website of NERPC: www.nerpc.gov.in.

Any commenys/observation may kindly be communicated to NERPC Secretariat at the earliest.

भवदीय / Yours faithfully,

(एस. एम. आइमोल / S. M. Aimol)

निदेशक / Director

Distribution List:

1. Managing Director, AEGCL, Bijuli Bhawan, Guwahati – 781 001
2. Managing Director, APGCL, Bijuli Bhawan, Guwahati – 781 001
3. Managing Director, APDCL, Bijuli Bhawan, Guwahati – 781 001
4. Managing Director, MSPCL, Electricity Complex, Keishampat, Imphal – 795 001
5. Managing Director, MSPDCL, Secure Office Bldg. Complex, South Block, Imphal – 795 001
6. Director (Transmission), MePTCL, Lumjingshai, Short Round Road, Shillong – 793 001
7. Director (Generation), MePGCL, Lumjingshai, Short Round Road, Shillong – 793 001
8. Director (Distribution), MePDCL, Lumjingshai, Short Round Road, Shillong – 793 001
9. Managing Director, TSECL, Banamalipur, Agartala -799 001.
10. Director (Generation), TPGCL, Banamalipur, Agartala -799 001.
11. Chief Engineer (WE Zone), Department of Power, Govt. of Arunachal Pradesh, Itanagar- 791111
12. Chief Engineer (TP&MZ), Department of Power, Govt. of Arunachal Pradesh, Itanagar- 791111
13. Chief Engineer (EE Zone), Department of Power, Govt. of Arunachal Pradesh, Itanagar- 791111
14. Engineer-in-Chief, P&E Department, Govt. of Mizoram, Aizawl – 796 001
15. Engineer-in-Chief, Department of Power, Govt. of Nagaland, Kohima – 797 001
16. ED (O&M), NEEPCO Ltd., Brookland Compound, Lower New Colony, Shillong-793003
17. ED (O&M), NHPC, NHPC Office Complex, Sector-33, Faridabad, Haryana-121003
18. ED, NTPC, Bongaigaon Thermal Power Project, P.O. Salakati, Kokrajhar- 783369
19. Vice President (Plant), OTPC, Palatana, P.O Udaipur, Gomati Dist., Tripura - 799105
20. ED, PGCIL/NERTS, Dongtiah-Lower Nongrah, Lapalang, Shillong -793 006
21. AGM (BD), NVVN, Core 5, 3rd floor, Scope Complex, 7 Institutional Area, Lodhi Rd., N. Delhi-3
22. Vice President, PTCIL, 2nd Floor, NBCC Tower, 15, Bhikaji Cama Place, New Delhi – 110066
23. Dy. COO, CTUIL, “Saudamini”, 1st Floor, Plot No. 2, Sector-29, Gurugram, Haryana – 122001
24. ED, NERLDC, Dongtiah, Lower Nongrah, Lapalang, Shillong -793 006
25. Chief Engineer, GM Division, Central Electricity Authority, New Delhi – 110066
26. Chief Engineer, NPC Division, Central Electricity Authority, New Delhi – 110066
27. ED, NLDC, Grid-India, B-9, Qutab Institutional Area, Katwaria Sarai, New Delhi-16
28. Head, Transmission, KMTL, 7th Floor, Fulcrum, Sahar Road, Andheri (E), Mumbai-400099

Copy To:

1. CGM, AEGCL, Bijuli Bhawan, Guwahati – 781001
2. CGM, APGCL, Bijuli Bhawan, Guwahati – 781001
3. CGM, (LDC), SLDC Complex, AEGCL, Kahilipara, Guwahati-781 019
4. Head of SLDC, Dept. of Power, Govt. of Arunachal Pradesh, Itanagar – 791111
5. Head of SLDC, MSPCL, Imphal – 795001
6. Head of SLDC, MePTCL, Lumjingshai, Short Round Road, Shillong – 793 001
7. Head of SLDC, P&E Deptt. Govt. of Mizoram, Aizawl – 796 001
8. Head of SLDC, Dept. of Power, Govt. of Nagaland, Dimapur – 797103
9. Head of SLDC, TSECL, Agartala – 799001
10. Chief Engineer (Elect), Loktak HEP, NHPC, Vidyut Vihar, Kom Keirap, Manipur- 795124
11. Addl GM (EED), NTPC Bongaigaon, P.O. Salakati, Kokrajhar- 783369
12. DGM (O&M), OTPC, Palatana, P.O Udaipur, Gomati Dist., Tripura – 799105
13. MD, NETC, 2C, 3rd Floor, D21 Corporate Park, DMRC Building Sector 21, Dwarka, Delhi-77.

(एस. एम. आइमोल / S. M. Aimol)

निदेशक / Director

North Eastern Regional Power Committee

MINUTES OF THE 25th NER TELECOMMUNICATION, SCADA & TELEMETRY

(NE-TeST) COORDINATION

SUB-COMMITTEE MEETING

Date : 25th May, 2023 (Thrusday)
Time : 10:30 hrs
Venue : “NERPC Conference Hall”, Shillong.

The List of Participants in the 25th NETeST Meeting is attached at **Annexure – I**

Shri K. B. Jagtap, Member Secretary, NERPC welcomed all the participants. He informed the following: -

(i) A review meeting on progress of Comprehensive scheme was taken by NERPC secretariat on 19.05.2023 at Guwahati wherein PowerGrid presented the detailed of T&D elements covered under Comprehensive scheme and its present status. He also informed the forum that progress of both the scheme will be monitored at regular interval.

(ii) He also informed that Chairman NERPC and Hon’ble Deputy Chief Minister Arunachal Pradesh has already written letter to MoP for PSDF funding for upgradation of SCADA System in NER state. NER State will send the DPRs of Establishment of VSAT system for Remote Substations (which was deemed returned by TESG committee, PSDF) with revised details as sought by TESG, PSDF Secretariat.

(iii) He further informed that 24th TCC/RPC meeting has been scheduled on 15th and 16th June 2023 at Tawang, Arunachal Pradesh.

Thereafter, the agenda items were taken up for discussion.

A. CONFIRMATION OF MINUTES

CONFIRMATION OF MINUTES OF 24th MEETING OF NETeST SUB-COMMITTEE OF NERPC.

The minutes of 24th meeting of NETeST Sub-committee held on 13th March, 2023 at Shillong were circulated vide letter No. NERPC/SE (O)/NETeST/2023/3625-2664 dated 31st March, 2023.

Following comment(s)/observation(s) were received from the AEGCL-

Agenda Item	Recorded in MoM	Comments (To be modified)
A.16	<p>.....</p> <p>GM(T&C), Comprehensive-PGCIL informed the forum that OPGW is already laid and FOTE is also commissioned. However, approach cable is yet to be laid between gantry and FODB. The link will be completed by 15th April 2023.</p>	<p>....</p> <p>GM(T&C), Comprehensive-PGCIL informed the forum that OPGW is already laid and FOTE is also commissioned. However, approach cable is yet to be laid between gantry and FODB. The link will be completed by 15th April 2023. AEGCL informed that if PGCIL uses AEGCL fiber for redundant of link, the End Equipment should have sufficient number of physical ports to interfacing AEGCL data traffic requirement along its rerouting and dropping data traffic to SLDC and Also Optical network along with End equipment will be under maintenance of PGCIL.</p>
B.1	<p>.....</p> <p>In this regard Sr. GM, NERTS informed the forum that he has already send the bid documents and contract agreement to all states. The forum requested NERTS to share all the relevant documents to all the states once again.....</p>	<p>AGM(SCADA) SLDC AEGCL informed that since for successful UNMS commissioning will require integration with different OEMs/SI of OEM product support and may be required some cards for integration with UNMS, the same need to be taken care by PGCIL.</p> <p>In this regard Sr. GM, NERTS informed the forum that he has already send the bid documents and contract agreement to all states. The forum requested NERTS to share all the relevant documents to all the states once again. Sr. GM, NERTS assured the same as above.</p>

The Sub-committee confirmed the minutes of 24th NETeST meeting of NERPC with above modifications.

A. ITEMS FOR DISCUSSION

A.1 Upgradation of SCADA/EMS of SLDCs:

SCADA was upgraded in 2015 with 7 years warranty, which has already expired. Hence, as per CEA regulations, existing SCADA needs upgradation. For this upgradation, MOU has already been signed with POSOCO presently known as Grid Controller of India Limited (Grid-India) for no cost consultancy with all SLDCs

Accordingly, the proposals were examined during the 74th Techno-Economic Sub-Group (TESG) meeting on 14.03.2023, in which the members decided that the SCADA/EMS upgradation of all NER SLDCs is deemed returned till further direction is received from Ministry of Power, Govt. of India, in this regard.

During the 202nd OCC meeting held on 18.05.23, it was informed that the Chairman, NERPC had written to the Ministry of Power for consideration of funding the Upgrade of the SCADA-EMS systems of NER states through PSDF.

Deliberation of the sub-Committee:

Member Secretary, NERPC informed the forum that the matter is in Ministry of Power, its status shall be reviewed in the next NETeST meeting.

The Sub-Committee noted as above.

Action: All state utilities, NERLDC & NERPC.

A.2 Cyber Security aspects in SCADA/IT systems at Load Despatch Centres in North Eastern Region:

State-Utilities may update the status with respect to CII Status by NCIIPC, ISO 27001:2013 implementation, VA-PT twice a year, Cyber Crisis Management Plan (CCMP), Cyber Management Team (CMT), patching of vulnerabilities and virus alerts from CERT-In/CERT-GO, etc, participation in various trainings and workshops on Cyber Security being conducted by CEA, Ministry of Power and POSOCO, etc. A summary of the state wise status of CII, CCMP etc., is attached as **Annexure A2**.

A CISOs meeting was conducted by Sh. M.A.K.P. Singh (CISO, Ministry of Power & Member-Hydro-CEA) in presence of NCIIPC representatives, CERT-GO and CERT-Hydro at NERLDC premises on 11th June 2022 in which wide participation from all CISOs of NER utilities was registered. It was emphasized that Cyber Security

guidelines laid down by CEA needs to be adhered with all stakeholders in power-sector and any difficulty being faced shall be reported to MoP/NCIIPC at the earliest.

Deliberation of the sub-Committee:

NERLDC updated the status of cyber security related activities to the forum. Member Secretary, NERPC appreciated that all the states except Arunachal Pradesh have submitted its compliance in the portal. He advised Arunachal Pradesh to submit its compliance in a timely manner & Arunachal Pradesh has agreed submit the same. Member Secretary also emphasized that cyber security is to be ensured by all the state utilities. He requested NERLDC to monitor the status of work of all SLDC in cyber security aspect and update the forum regularly. A summary of the state wise status of CII, CCMP etc., is attached as **Annexure A.2**.

State utilities highlighted the issue of IT manpower posted in SLDCs for cyber security purpose. Member Secretary, NERPC informed the forum that the IT Manpower in SLDCs matter will be stressed in the forthcoming TCC/RPC.

The Sub-Committee noted as above.

Action: All state utilities, NERLDC & NERPC.

A.3 Implementation of Guwahati Islanding Scheme:

During the 23rd TCC/RPC, The Guwahati Islanding Scheme was referred back to the Sub-Committee for review as the forum felt that the cost estimate of ₹84.88Cr (including taxes) is exorbitant. In the 24th NETeST meeting, it was decided that the empowered committee members of Guwahati Islanding scheme might discuss the issue.

In this regard, a special review meeting was held on 17th April, 2023. After detailed deliberation, it was decided that the communication part of this scheme shall be executed under Reliable communication scheme. M/s GE is being consulted for simplification of the scheme & reduction of the cost. Revised offer from M/s GE is awaited.

Deliberation of the sub-Committee:

DD, NERPC informed that M/s GE, OEM of the conceived project of Guwahati Islanding has been instructed to review the DPR in line with the Islanding scheme of Jabalpur, a PMU based islanding scheme for minimizing the cost. After further deliberation, the forum advised the empowered committee members to approach other similar vendor for better pricing. Member Secretary, NERPC secretary advised

to conduct a physical meeting with vendor/OEM and iron out the issues at the earliest.

The Sub-Committee noted as above.

Action: AEGCL, NTPC, POWERGRID, NERLDC & NERPC.

A.4 Periodic Auditing of Communication System:

Regulation 10 of Communication System for inter-state transmission of electricity Regulation, 2017 states “*The RPC Secretariat shall conduct performance audit of communication system annually as per the procedure finalized in the forum of the concerned RPC. Based on the audit report. RPC Secretariat shall issue necessary instructions to all stakeholders to comply with the audit requirements within the time stipulated by the RPC Secretariat. An Annual Report on the audit carried out by respective RPCs shall be submitted to the Commission within one month of closing of the financial year*”.

Accordingly, Audit plan has been made for FY 2023-24 (List of stations to be audited is attached as **Annexure A.4(a)**). Constituents are requested to nominate an officer for formation of the audit team as and when required.

Deliberation of the sub-Committee:

DD, NERPC informed the forum that communication audit is essential as per CERC regulation and few Sub- stations for audit has been selected (based on its data traffic) and states can also suggest additional names of substation (as per requirement) i.e to be audited. After detailed deliberation, the forum decided that nomination for audit committee from states/ISTS shall be sought as and when required. All the states agreed to the same. As advised by Member Secretary, NERPC the audit format is attached as **Annexure A.4(b)**.

The Sub-Committee noted as above.

Action: All state utilities, ISTS/ISGS Licencee, NERLDC & NERPC.

A.5 Procedure on Outage Planning for Communication System:

Regulation 10 of Technical Standards for Communication System in Power System Operations Regulations, 2020 states, “*Monthly outage shall be planned and got approved by the owner of communication equipment in the concerned regional power committee, as per detailed procedure finalized by the respective regional power committee*”.

Accordingly, draft SOP on “Procedure on Outage Planning for Communication System” is attached as **Annexure A.5**.

Deliberation of the sub-Committee:

After detailed deliberation, the forum agreed to the procedure detailed in **Annexure A.5**. NERLDC requested that the shutdown discussion for communication system may be done along the OCC shutdown meeting. The forum agreed to the same.

The Sub-Committee noted as above.

Action: All state utilities, ISTS/ISGS Licencee, NERLDC & NERPC.

A.6 Non-availability of real-time data pertaining to POWERGRID-owned bays installed at AEGCL-owned stations:

It has been observed that the real-time data of POWERGRID-owned bays installed at AEGCL stations are not reporting to NERLDC. These bays have been identified as follows –

- a. Nirjuli bay installed at Gohpur station since 16th Dec-2022
- b. Silchar bays installed at Srikona station isolator data since 28th November - 2022.
- c. Silchar bays installed at Hailakandi.

All these bays are ISTS elements, thus data availability is important for real-time drawl calculation and monitoring of ISTS element. During 24th NETeST meeting, it was decided that AEGCL and POWERGRID will jointly work to resolve the matter bilaterally at the earliest.

Deliberation of the sub-Committee:

AEGCL informed the forum that Bay Controller Unit (BCU) of Nirjuli bay installed at Gohpur substation is not compatible with SAS of Gohpur (AEGCL). Presently the BCU is under upgradation and the same shall be completed by June-2023.

AEGCL informed that isolator of Silchar bay at Srikona is not compatible with SAS. In this regard, AEGCL and NERTS has agreed to conduct a joint visit to Srikona station to identify and resolve the issue within one month.

AEGCL informed that for Silchar bays installed at Hailakandi, there is problem in SAS gateway. Matter has been taken up with OEM and it is expected to rectify the issue within thirty days.

The Sub-Committee noted as above.

Action: AEGCL & POWERGRID.

A.7 Connectivity of 132 kV Khupi S/s with ULDC network:

132 kV Khupi S/s will be connecting to Kameng HEP over 132 kV line. Thus, it is requested to connect 132 kV Khupi S/s with ULDC network by installing OPGW and associated end equipment.

During 24th NETeST meeting, GM (T&C), Comprehensive-PGCIL informed the forum that OPGW stringing is completed in 132 kV Khupi-Kameng (Kimi) line, FOTE installation is under progress which will be completed by 15th April 2023.

Deliberation of the sub-Committee:

DD, NERPC informed the forum that Comprehensive-POWERGRID has assured to complete all the pending work by the end of May, 2023.

The Sub-Committee noted as above.

Action: Comprehensive-POWERGRID.

A.8 Voice Communication issue at 400kV Palatana (OTPC) station:

It was observed that the VOIP phone installed at 400kV Palatana station is frequently interrupted and highly un-reliable. Therefore, OTPC is requested to re-install a new VOIP phone in main control-room over ULDC network.

During 24th NETeST meeting, OTPC representatives were not present in the meeting. NERLDC was requested to communicate through e-mail to OTPC to take necessary action, with copy to NERPC.

NERLDC has mailed to OTPC on 18th May 2023 for establishment of VoIP phone along with port details of communication link.

Deliberation of the sub-Committee:

DD, NERPC informed the forum that OTPC has informed (over telephone) that the link has been established between Palatana and NERLDC. OTPC is purchasing media convertor and the connectivity of the phone shall be completed within 02 weeks.

The Sub-Committee noted as above.

Action: OTPC & NERLDC.

A.9 Related to commissioning of 220 KV downstream transmission line of DOP Nagaland at New Kohima (400/220kV) SS Concerns of KMTL:

1. OPGW wire for 220 KV downstream Transmission line has not been installed so it is very difficult to achieve the protection of 220 KV transmission line by using line

differential relay. As line length is 10 KM (Approx.) for 220 KV Transmission line therefore Line differential Relay has been considered for both the end.

2. PLCC & SDH panel has not been installed at 400/220 KV GIS substation, New Kohima till date.

3. 220 KV downstream transmission line conductor parameters yet to receive from DOP, Nagaland for Relay setting at 400/220 KV GIS substation, New Kohima.

In 196th OCCM, Manager, KMTL requested the forum to ensure installation of OPGW, LDP, PLCC, SDH equipments in the 220kV downstream line. He also requested for providing parameters to KMTL for finalization of settings. Member Secretary, NERPC requested POWERGRID to include OPGW for the 220kV New Kohima – Zhadima D/C under regional scheme – State Sector and proceed for early implementation as the line is in final stage of commissioning. NERTS agreed to the same.

In the 24th NETeST meeting forum requested ULDC-POWERGRID to check the possibility to include the link under ongoing project. Sr. GM, NERTS informed the forum that he will check the possibility and update accordingly.

Deliberation of the sub-Committee:

POWERGRID informed that there is a scope for inclusion of the above links in the ongoing Reliable Communication Scheme (awarded to M/s APAR industries Ltd) subject to approval at RPC. The forum recommended that the above-mentioned works for RPC approval.

The Sub-Committee noted as above.

Action: DoP, NAGALAND & NERPC.

A.10 Issues of SLDCs in SCADA AMC:

Assam, Meghalaya and other SLDCs:

(a) Signing of LOA for Extension of AMC of SCADA-EMS system of Meghalaya:

The AMC of the existing SCADA-EMS system for Meghalaya had expired on 31st March 2023. However, GE is yet to sign the LOA which incorporates the GST related amendment made by POWERGRID besides other terms and conditions as in the Original Contract. Moreover, a request was made by GE for a consideration of the Maintenance component only (exclusive of Supply and Services) for the purpose of PBG.

Deliberation of the sub-Committee:

SLDC Meghalaya requested M/s GE to sign the LOA for Extension of AMC without any deviation in line with the LOA extension signed with SLDC, Assam. After detailed deliberation, the forum advised M/s GE to adhere to the GCC of the original contract. M/s GE representative agreed to sign the LOA extension.

The Sub-Committee noted as above.

Action: SLDC Meghalaya & M/s GE.

(b) Degraded performance of the UPS battery banks of Meghalaya SLDC:

During the 24th NETeST meeting, GE had assured that all issues relating to the inadequate performance of UPS battery banks would be resolved. However, subsequent to the last Preventive Maintenance Visit on the 20th March 2023 wherein it was observed that UPS-1 battery bank was giving a backup of less than 2 hours along with the detection of defective battery cells, there has seemingly been no effort on the part of GE to resolve the problems.

Deliberation of the sub-Committee:

SLDC Meghalaya requested M/s GE to ensure the availability ups battery supply for at least 3.5 Hrs. In this regard, M/s GE assured the same and informed that 30 nos. battery shall be supplied to SLDC, Meghalaya & installed by June, 2023.

The Sub-Committee noted as above.

Action: SLDC Meghalaya & M/s GE.

(c) Support for Fortinet Firewall during Extended AMC:

The license of the internal firewall of the SCADA/EMS system of SLDC, AEGCL has already expired. As per M/S GE T&D Ind. Ltd. the, OEM of the firewall does not support for any further extension in the service/ licence. The matter has already been discussed in several meetings. As per the minutes of the special meeting dated 13.02.2023 SLDC, AEGCL has written a letter to CERT-GO & CISO-MOP seeking clarification and guidance on this issue, however, no response has been received yet. Also, once the firewall issue is resolved, specific amendment in LOA may be made as per requirement.

Deliberation of the sub-Committee:

Member Secretary, NERPC informed the forum that CISO-MoP is being requested to guide on the matter during ensuing TCC/RPC meeting.

The Sub-Committee noted as above.

Action: NERPC.

(d) GST related amendment in AMC of the SCADA-EMS system:

Since the Contract was originally prepared by POWERGRID and signed by individual states with ALSTOM / GE, the matter relating to the amendment in GST and calculations thereof was requested during meeting dtd 29.12.2022 to POWERGRID.

A letter has been received from Powergrid on 31.03.2023. Point No. 3.0 states that “The rate is approved as 89% [Eighty Nine percentage] of the original rate of the AMC portion”. Another email has been received from M/S GE T&D Ind. Ltd. on 12.05.2023, in which revised rate for AMC calculation has been shared. As per the calculation the existing contract value is Rs. 1,65,62,935 .00. And the Contract value after GST amendment is Rs. 1,73,94,394.00. While calculating the same M/S GE T&D Ind. Ltd. has taken 89% of the original contract value which is inclusive of service tax of 12.36%. So, there is no change in the base value after GST amendment. However, there is significant enhancement in the contract value.

Deliberation of the sub-Committee:

SLDC, Assam informed the forum that the AMC cost for state has been escalated in the GST related amendment proposed by Powergrid. However, the AMC cost has remained same for NERLDC in spite of same contract. NERLDC acknowledged the same and informed that they will update the forum on this matter in the next NETeST meeting.

SLDC, Meghalaya also informed that they have discussed the issue with POWERGRID. POWERGRID has agreed to share the corresponding calculation sheet with the states. POWERGRID informed the forum that if other state wants GST amendment calculation, they need to give details to POWERGRID and Powergrid will provide the separate GST amendment to each state.

The Sub-Committee noted as above.

Action: All state utilities & NERLDC.

(e) Reconciliation of the Spares for ASSAM SLDC:

SLDC, AEGCL would like to inform the forum that the AMC for SCADA/EMS awarded to M/S GE T&D Ind. Ltd. has been extended for two years at the same rate and same terms and condition as per the provision in the existing AMC. As such SLDC, AEGCL would like to reconcile the spares that the contractor needs to maintain at site in presence of the contractor.

Deliberation of the sub-Committee:

After detailed deliberation, SLDC, Assam & M/s GE agreed to reconcile by 1st Week of June, 2023. Member Secretary, NERPC advised all other states to reconcile the materials as per BoQ.

The Sub-Committee noted as above.

Action: All state utilities & M/s GE.

(f) Replacement of anti-virus installed in OT system of LDCs in NER:

M/s GE T&D India Limited has provided Microsoft System Center Endpoint Protection (SCEP) 2012 as antivirus solution for the SCADA system during the project implementation phase. The anti-virus installed has been declared end-of-life by the OEM i.e., Microsoft from 12-July-2022 onwards which means that all associated definitions, engine, and platform updates will not be available now. Non-availability of antivirus is a critical cyber security vulnerability to the system. Therefore, M/s GE T&D India Limited has to replace and maintain an updated antivirus solution in SCADA system at all LDCs of NER. Further, all SLDCs have to follow up with M/s GE T&D India Limited regarding implementation of the same on priority basis.

In 23rd NETeST meeting, M/s GE informed the forum that they will replace all the obsolete antivirus by a new eSCAN anti-virus solution till 10th August 2022 at NERLDC as well as NER-SLDCs.

In 24th NETeST meeting, M/s GE T&D Ind. Ltd. representative requested all SLDCs to inform this issue to the site engineer and M/s GE will resolve it expeditiously.

Deliberation of the sub-Committee:

M/s GE representative informed that in view of cyber security, internet is not directly connected to the SCADA systems and therefore regular updates of antivirus software could not be undertaken. However, M/s GE requested all SLDCs to provide a dedicated workstation class computer system which shall be configured as Anti-virus management server. The computer should have internet facility to download the patches and will be connected to SCADA external firewall to push the patches to respective systems.

The Sub-Committee noted as above.

Action: All state utilities & M/s GE.

(g) Deployment of Suitable Manpower at LDCs in NER for AMC by M/s GE T&D

India Limited:

SCADA/EMS project was awarded to M/s GE T & D Limited in the year 2014 and T&C extended during January 2017. Since then, the SCADA/EMS system is under Comprehensive-AMC with M/s GE T&D Limited. As per the contractual terms and conditions, two (02) manpower with “5 years of working experience in delivered SCADA/EMS system” has to be deployed at each SLDC of North-Eastern Region.

It has been observed that manpower deployed at various SLDCs are not as per the provision of the contract and due to this many-a-times, technical support through remote desktop needs to be extended from NERLDC. As a result, various works are getting hampered and delayed.

In 23rd NETeST meeting, M/s GE assured to the forum that all issues related to manpower will be resolved before next NETeST meeting. It was deliberated that M/s GE should not take this matter lightly and fulfil the requirements as per the provision of the contract which quotes that service engineer with minimum 5 years of working experience in delivered SCADA/EMS system should be deployed at all control centers.

In 24th NETeST meeting, M/s GE T&D Ind. Ltd representative informed that they will be sending experts from back office on quarterly basis to each SLDC, for resolving state issues as well as training each personnel deployed there. Further, online training will also be provided to all their deployed personnel. He assured the forum that man-power related issue at all SLDCs will be resolved by April 2023.

Deliberation of the sub-Committee:

M/s GE informed that necessary training has been imparted to the site engineers and their performance are being monitored on a regular basis. They also requested all the SLDCs to inform any lagging of the site engineers for smooth execution of the contract. SLDC, Assam informed that the training imparted appears to be inadequate as the site engineers of M/s GE often seeks remote help for regular works. The forum advised M/s GE to look into and resolve the matter urgently. M/s GE agreed for the same .

The Sub-Committee noted as above.

Action: All state utilities & M/s GE.

(h) Non-functioning of “Historian” system services at Mizoram SLDC and Arunachal Pradesh SLDC:

The historian system services in SCADA/EMS system of Mizoram SLDC and Arunachal Pradesh SLDC are not functioning since its inception. During 24th NETeST meeting, M/s GE T&D informed the forum that they will resolve the issue by 15th April 2023. Further, NERLDC also requested concerned constituents to calculate the availability according to contract clause if the issues are not resolved by 15th April 2023.

Deliberation of the sub-Committee:

M/s GE informed the forum that historian services are restored at Mizoram SLDC on 15th May 2023, Mizoram SLDC has also confirmed the same. Regarding Historian of SLDC, Arunachal Pradesh M/s GE informed that one of historian storage server has been restored and the historian functionality shall be restored by 15th June 2023; for the second historian storage server, the hardware issue has been identified and the same shall be rectified by July, 2023.

The Sub-Committee noted as above.

Action: SLDC, Arunachal Pradesh & M/s GE.

(i) High utilization of RAM in Communication Front End (CFE) server at Nagaland SLDC, Mizoram SLDC and Arunachal Pradesh SLDC:

It has been observed in the SCADA/EMS system of Mizoram SLDC and Arunachal Pradesh SLDC that CFE server has a high Random-Access-Memory (RAM) utilisation since more than 4 months. This leads to system lagging/hang and also could result in stopping of data flow in the SCADA system. During 24th NETeST meeting, M/s GE T&D informed the forum that they will resolve the issue by 31st March 2023. Further, NERLDC also requested concerned constituents to calculate the availability according to contract clause if the issues are not resolved by 31st March 2023.

Deliberation of the sub-Committee:

M/s GE informed the forum that high utilization of RAM in Communication Front End (CFE) server at Nagaland SLDC, Mizoram SLDC and Arunachal Pradesh SLDC was due to some process of eSCAN anti-virus writing multiple repeated entries in some specific files. The problem has now been rectified. All concerned SLDCs concurred the same.

The Sub-Committee noted as above.

(j) Battery Bank issues of Tripura SLDC.

Regarding replacement of deteriorated batteries of 40 KVA UPS system in Tripura & Assam. It was already discussed in SCADA AMC meeting, however GE has not taken action till date.

Deliberation of the sub-Committee:

M/s GE informed that 30 nos. battery shall be supplied to SLDC, Tripura by June, 2023.

The Sub-Committee noted as above.

Action: SLDC, Tripura & M/s GE.

A.11 Concerned regarding shifting of SLDC Arunachal Pradesh from Old building to new building.

It is to inform the forum, SLDC Arunachal Pradesh has completed its new control centre building, which is nearby to exiting SLDC building (Chimpu S/s). However, following are concerns from NERLDC:

- a) Plan for Comprehensive-AP, ULDC and Powertel links connectivity of new building.
- b) Plan for shifting SCADA/EMS system.
- c) Plan for shifting VoIP exchange.

Deliberation of the sub-Committee:

DoP, Arunachal Pradesh informed the forum that the discussion is being held with M/s GE T&D for shifting the SCADA/EMS system from old premises to new premises. NERLDC emphasized that along with SCADA/EMS, plan for shifting of VoIP exchange and communication links (POWERTEL, ULDC and Comprehensive-AP) should also be prepared well in advance. Member Secretary, NERPC advised DoP, Arunachal Pradesh to plan the activities with minimal outage. DoP, Arunachal Pradesh informed the forum that the matter is in initial discussion phase and further brainstorming would be done on it before presenting it to the forum.

The Sub-Committee noted as above.

Action: SLDC, Arunachal Pradesh, M/s GE & NERLDC.

A.12 DCPS failure at 132 kV Daporijo S/s

It is learnt that after one of fire incident at 132 kV Daporijo S/s, DCPS (DC Power System) is not functional at the stations. This has led to failure of PLCC communication with adjacent stations i.e., Ziro (PG) and Basar (DoP-AR). As a

consequence, the communication path for reporting Daporijo and Basar RTU is not available.

Deliberation of the sub-Committee:

DoP, Arunachal Pradesh informed the forum that they are procuring the DCPS system for the substation.

The Sub-Committee noted as above.

Action: SLDC, Arunachal Pradesh.

A.13 Introduction of MPLS Technology in ISTS Communication:

- a) Presently most of the ISTS networks are based on SDH technology with suitable redundancy. From the recent market trends, it is evident that Telecom Service Providers have started using MPLS based networks because of its embedded benefits like high Band Width efficiency, availability of various Quality of Service (QoS) for different applications. This has led to reduction in the chip production of SDH equipment and SDH equipment are thus getting obsolete for future projects and also for maintenance of the existing SDH system.
- b) In order to evaluate latest market trends and views of various stakeholders, CTU has organized a Seminar on MPLS Technology in Jan'23. The Seminar was attended by participants from CEA, RPCs, CERC, Grid-India, STUs, Transmission Licensees, POWERGRID, MPLS Service providers both in person and online.
- c) During the seminar the MPLS service providers viz, NOKIA, HITACHI, SIEMENS, CISCO, GE & Tejas made elaborate presentations followed with an interactive Q&A session. It emerged out that introduction of MPLS technology in Power Sector has become essential and can not be carried out with the current SDH technology for more time. However, many challenges are involved in Power Sector for monitoring and operation of Grid using applications such as SCADA, PMU, VoIP, Protection, AGC, Tele-Protection etc. Power System applications for Grid Operation compared to Telecom and Internet services are more critical as these applications require real time monitoring, low latency, redundancy and high reliability. Considering the same, the MPLS technology needs to be explored suitably for Power Sector communication requirements for new projects.
- d) Another major challenge would be dovetailing of the legacy ISTS SDH communication networks constituting of approximately 70000 kms of OPGW. The existing SDH system shall be rolled out in a phased manner as it lives its life.

- e) The above-mentioned aspects were detailed by the MPLS service providers and both options of MPLS i.e. TP & IP were advised.
- f) It is also learnt that some STUs are using MPLS networks for the their Intra-State communication and they may share the detailed usage of the same.
- g) It is proposed that the matter may be deliberated in depth with the various stakeholders to introduce the appropriate technology of MPLS for the new ISTS communication system elements and integration of the same with the existing SDH network. It is also proposed that a Pilot Project may be carried out to examine the various power system applications (SCADA, PMU, VoIP, Protection, AGC, Tele-Protection etc.) on MPLS network and bridging with existing SDH network.

Deliberation of the sub-Committee:

CTUIL made a brief presentation through VC (attached as **Annexure A.13**) to the forum. After detailed deliberation, the forum decided the all SLDCs shall study the pros & cons for implementing the MPLS technology in its state grid and update the forum in the next NETeST meeting.

The Sub-Committee noted as above.

Action: All SLDCs.

A.14 Congestion in ISTS communication network:

The communication networks have STM16 link capacity at most of the places, however few links having STM4 or lesser capacity. There may be few links /nodes the capacity of whom may have been utilised more than 75 percent. The detail of such nodes/links may be intimated by POWERGRID/ Grid-India which are having congestion in terms of traffic/bandwidth so that planning for capacity enhancement of the node/link may be done.

This agenda was discussed in 3rd Communication planning meeting(CPM) of CTUIL held on 22.12.2022 wherein, it was informed by POWERGRID and Grid-India that as of now there are no such nodes/links. CTUIL requested that such nodes/links may be identified and intimated in the future also.

Deliberation of the sub-Committee:

The forum noted the same and advised POWERGRID to identify and regularly update the forum if the capacity of any node/link has been utilized by more than 75%.

The Sub-Committee noted as above.

Action: POWERGRID & CTUIL.

A.15 Compliance for Resource disjoint as per CEA manual of communication planning for power system operation dtd 31.03.2022:

As per CEA manual of communication planning for power system operation dtd 31.03.2022, to ensure redundancy with route diversity, the working path and protection path should be resource disjoint. There may exist Single Points of Failure (SPOF) in network where multiple links are aggregating to single node and failure of such node may result in failure of multiple nodes and thus the Grid visibility. Such nodes in ISTS communication network may be identified and intimated by POWERGRID/Grid-India which are SPOF. The redundancy and resource disjoint of such links to be further ensured considering their criticality in system.

This agenda was discussed in 3rd Communication planning meeting(CPM) of CTUIL held on 22.12.2022 wherein, POWERGRID/ Grid-India agreed that such nodes/power supply in the network shall be identified and informed to CTUIL as per agenda.

Deliberation of the sub-Committee:

NERLDC requested CTUIL to make communication network of NER grid including nodes of all upcoming schemes to identify such nodes. CTUIL informed that they will share the communication map. The forum advised CTUIL to inform the critical node identified by PGCIL/CTU to the forum.

The Sub-Committee noted as above.

Action: CTUIL.

A.16 Additional FOTE at AGC locations:

Additional FOTE at all AGC operated generating stations in North Eastern region is required in view of resource disjoint and criticality of AGC operation for grid operation purpose as failure of single equipment may lead to disruption in AGC operation. Further, at many locations redundant ethernet port are not available as per NLDC requirement. The NLDC requirement is as follows:

- 1+1 Ethernet port for main NLDC
- 1+1 Ethernet ports are for backup NLDC

This is to be deliberated for additional FOTE and ports/cards at AGC locations.

The list of AGC locations are as follows:

a) Loktak b) Bongaigaon

POWERGRID may provide details of existing FOTE and requirement of additional ports/cards/FOTE at these AGC locations in view of above.

POWERGRID informed as follows:

a) At Loktak : Redundant port as per NLDC requirement is available but additional FOTE would be required.

b) At Bongaigaon: There are two FOTE one of FIBCOM make and another of ECI make. All the ports in ECI FOTE are exhausted but in FIBCOM FOTE spare ports are available. As ECI equipment can't be procured and shifting of links from ECI FOTE to FIBCOM FOTE will have to be checked. POWERGRID intimated by e-mail that as per NLDC requirement, spare ports are available but additional FOTE is required.

Accordingly, one no. of FOTE STM-16 at Loktak and One no of FOTE STM-16 at Bongaigaon is proposed.

Deliberation of the sub-Committee:

After detailed deliberation, the forum requested POWERGRID to check if the above works can be accommodated in the Reliable Communication scheme & update it in the next NETeST /RPC meeting.

The Sub-Committee noted as above.

Action: POWERGRID.

A.17 Connectivity of STU node on fibre in view of AMR.

The meter readings from several locations (mostly STU nodes) (list of location shall be provided by Grid-India) in each region are intermittent and having communication issues as the meters at the state nodes are not having secure & reliable communication links and are operational on public domain communication links like GPRS. It is proposed to provide the connectivity of such nodes on captive OPGW network for receiving the data successfully for AMR purpose.

Grid-India has identified a list of such nodes (list attached as **Annexure A.17**) for each region.

The line length (for the STU nodes as listed in **Annexure A.17**) from STU node to nearest ISTS node may be provided by Grid-India/STU/State constituent along with line name, line ownership so as to prepare a scheme for OPGW laying.

After the deliberation, the scheme shall be put up for approval in NCT.

Deliberation of the sub-Committee:

After detailed deliberation, the forum requested CTUIL to furnish data format to states so that exact data is made available to CTUIL as requested.

The Sub-Committee noted as above.

Action: CTUIL.

A.18 Redundancy philosophy in case of availability of only one transmission line from one ISTS/ISGS station to the DCP:

In many cases, specially in the case of terminal nodes, it is observed that they are connected to only one transmission line and protection path via alternate OPGW on separate transmission line is not feasible. In this scenario, for providing protection path following options may be explored:

- a) OPGW on same transmission line on second peak.
- b) VSAT
- c) Lease line

This agenda was deliberated in meeting among all RLDCs, POWERGRID, CTUIL,CEA. The deliberation for which is as follows.

Deliberation:

POWERGRID expressed concerns on “Communication Availability” in view of OPGW on same tower on second peak, VSAT & leased line. POWERGRID requests CTUIL & POSOCO to clarify on the communication availability in case both OPGW outages occur (same tower having two OPGWs or OPGW-ADSS) & in case downtime of VSAT due to weather conditions.

Grid-India replied that NPC has already released the Communication Availability criterion & POWERGRID’s concerns will be considered at the time of planning.

CTUIL stated that for such cases, OPGW on second peak of same transmission line is sufficient as a redundant path. Further, ADSS may be opted for where second peak for the same transmission line is not available

This is for information in TeST forum.

The Sub-Committee noted as above.

A.19 Recovery of cost of VSAT scheme in Roing, Tezu, Namsai and Shillong:

It was approved in 20th NERPC meeting that the project implementation cost for VSAT scheme in Roing, Tezu, Namsai and Shillong would be recovered one time from NER states. However, the modalities of recovery process and share of each constituent was not decided.

It may also be noted that the system has already been commissioned on 00:00hrs dtd 09.04.2021. Total project cost as per LOA is INR 68,15,021(Excl. of GST).

Deliberation of the sub-Committee:

After detailed deliberation, the forum referred the agenda to the next CCM meeting.

The Sub-Committee noted as above.

Action: POWERGRID & NERPC.

A.20 UNMS:

UNMS workstation is being installed at 7 SLDCs of NER along with main & backup system at Guwahati & Shillong. The existing UPS is to be used for providing power to this system. However, some of the constituents are objecting for the same.

Deliberation of the sub-Committee:

POWERGRID informed that 6KVA UPS are being procured and the same shall be at site by July, 2023. However, to install the UNMS workstation, about 1.2 Kwh UPS power may be provided as a stop gap arrangement. SLDC, Meghalaya & SLDC, Nagaland agreed to the same. TSECL informed that they will provide power from the existing UPS system of the SLDC & they do not require the 6KVA UPS presently being procured by POWERGRID.

The Sub-Committee noted as above.

Action: All concerned SLDCs & POWERGRID.

TSECL:

For installation of UNMS equipment, required space has been allotted by TSECL at Tripura SLDC Control room by rearranging the existing equipment in the panel & server room on urgent basis for immediate commissioning along with supply as there is severe space constraints. This has been agreed by the Sterlite before delivery of materials.

However Sterlite has dumped in insecure way the supplied UNMS materials in the middle of the panel room which is causing inconvenience to carry out day to day maintenance activities by TSECL & Powergrid Telecom.

Deliberation of the sub-Committee:

POWERGRID informed that hardware/furniture has been supplied at site. For the installation, the team along with the project in charge shall be deployed at site by 1st week of June, 2023.

The Sub-Committee noted as above.

Action: POWERGRID & TSECL.

A.21 Routing of DATA of Roing-Chapakuwa line through AEGCL Network:

For Roing-Chapakuwa line, the data validation of the Roing site has been completed but pending for Chapakuwa site as the link between Rupai-Tinsukia is down(which is

in the scope of AEGCL). On the other side, Roing-Chapakuwa link is tentatively getting ready by 28.05.2023. Once it is ready, a link will be established between Roing & Chapakuwa and Chapakuwa's telemetry data can be made available to NERLDC end via Roing through VSAT communication system and data validation can be done. AEGCL may kindly grant the permission for reporting of Chapakuwa data to NERLDC end for data validation.

Later, after rectification of Rupai-Tinsukia link, AEGCL may kindly share BW of 10mbps to establish redundancy path through ULDC network for connectivity of Roing, Tezu, Namsai and Chapakuwa. Request letter has already given to CGM(T&C & Comm), Guwahati vide ref. no. NESH/Add-Pkg-I/ULDC/918 dt 11.04.2023.

Deliberation of the sub-Committee:

AEGCL agreed to share 10 mbps bandwidth but requested POWERGRID/NERSIP to do the inter-patching works. After detailed deliberation, it was decided that POWERGRID & NERPSHIP would do the inter-patching works with help from AEGCL.

The Sub-Committee noted as above.

Action: POWERGRID, NERPSIP & AEGCL.

A.22 Revival of Non-reporting GPRS based Telemetry link:

Delay in the commissioning of OPGW communication links under NERPSIP is hampering real-time telemetry data availability.

Nodal Powergrid is requested to take up the matter with PMAS (Supplier, Installation & commissioning) agency for revival of Non-reporting RTU stations under the GPRS based RTU data telemetry scheme as the OPGW communication links under NERPSIP is getting much delayed. This is very essential to increase the telemetry data availability of Tripura.

Deliberation of the sub-Committee:

POWERGRID informed the forum that as per the scope of the original contract there was no scope for AMC. After taking over, AMC was to be ensured by the respective states. The forum requested POWERGRID to take up the issue with the vendor. POWERGRID agreed to the same and shall try to rectify the issue within two weeks.

The Sub-Committee noted as above.

Action: POWERGRID & TSECL.

A.23 Issues related to Powergrid:

1. AMC under NERFO project:

- Request of visit from Powergrid/AMC agencies to assess the condition of the FO equipment at field level as well as periodical maintenance.
- Backup issue (No backup) of 48V DCPS at Baramura is not attended till date. Panels are getting abrupt shutdown during mains failure.

Deliberation of the sub-Committee:

POWERGRID informed the forum that the scope of the contract is maintenance of the SDH panel. Accordingly, two nos. persons have been deployed for NER region who undertake maintenance works quarterly.

The Sub-Committee noted as above.

Action: POWERGRID.

2. Incorporation of AMC of strung OPGW under the NERFO project:

- As the project is running for the entire NER, there should be scope of combined AMC for strung OPGW.
- Request for immediate visit & rectification of Fiber link over Udaipur – Gumati TL as a visit was scheduled on 02nd May 2023 but not attended by the agency Steel Product till date.

Deliberation of the sub-Committee:

POWERGRID informed the forum that as per the scope under NERFO, there is no modalities for AMC after handing over. States were to take up the AMC works. TSECL informed that they lack the resources & expertise for maintenance of OPGW networks. POWERGRID agreed to share the BoQ of AMC for the existing contractor with TSECL and any further help required by states for executing the AMC.

The Sub-Committee noted as above.

Action: POWERGRID & TSECL.

A.24 Establishment of redundant fibre path between NERLDC and NEHU for reliability of power system communication link:

On 05-01-2023 and 06-01-2023, there were two incidents of fibre cut between NERLDC and NEHU, during the incident all communications links, such as internet, all ULDC links of ICCP, URTDSM, VOIP, RTUs and all POWERTEL links catering the functionality of NERLDC real time system were affected. Consequently, NERLDC

control room was not having any data of grid station which led RLDC to operate grid blindly. Due to outage of this link SLDC and NLDC were also not able to receive data from NERLDC. This 24-core fibre currently runs partially as OPGW on 132 kV NEHU-Kheliriat line and partially as UGFO cable. The fibre is under the ownership of POWERTEL & ULDC has been allotted some pair of fibres from it.

Considering the critical functions of LDCs, it is requested to ULDC-POWERGRID to lay 24 core FIBRE between NERLDC Shillong and NEHU, which should be in physically different path to that of POWERTEL fibre and complete ownership of new fibre should be with ULDC-POWERGRID.

During 24th NETeST meeting, Sr. GM, NERTS informed the forum that survey has already been carried out for a redundant path via UGFO from 132 kV Nehu-Khlierihat-1 circuit. The forum requested NERTS to include this link in the reliable communication project as this is a very important link in the ULDC network. Sr GM, NERTS further clarified that the link could be taken up under central sector if the same was approved by NERPC as this was for the common benefit of all the constituents.

Deliberation of the sub-Committee:

POWERGRID informed the forum that there is existing OPGW on 132 kV NEHU-Kheliriat line I till tower no. 25 under MW vacation project. The forum requested ULDC POWERGRID to lay 24 core UG FIBRE between NERLDC Shillong and 132 kV NEHU-Kheliriat line I Tower no. 25 under Reliable communication scheme.

The Sub-Committee noted as above.

Action: POWERGRID & NERPC.

B. ITEMS FOR STATUS

B.1 Project status of NERPSIP and Arunachal Pradesh Comprehensive Scheme:

Latest status may please be updated by implementing agencies for information ensuing TCC/RPC forum. Any issue shall be discussed in the monthly review meeting of NETeST subgroup.

Deliberation of the sub-Committee:

The progress of NERPSIP and Arunachal Pradesh Comprehensive Scheme shall be regularly taken in the NETeST sub group.

The Sub-Committee noted as above.

Action: NETeST sub group

B.2 Status of FO works under different projects.

Status as updated in the 25th NETeST meeting:

SN.	Link name	Utilities	As per 25 th NETeST
I. Fiber Optic Expansion Projects			
Meghalaya State Sector			
1	132kV NEHU - NEIGRIMS	POWERGRID-NERTS	MS, NERPC suggested to carry out a separate meeting probable next week between NERPC, NERLDC, SLDC Meghalaya, POWERGRID ULDC & POWERTEL to discuss the matter.
Central Sector			
2	400kV Bongaigaon (PG) - 220kV Salakati - 220kV BTPS	POWERGRID-NERTS	<ul style="list-style-type: none"> New ROW issues have aroused. Target: August 2023.
3	400kV Mirza (Azara) – Byrnihat		
4	400kV Silchar – Palatana		<ul style="list-style-type: none"> Stringing completed. Unhealthy stretch of 25-30 KM requires replacement. There are some contractual issues which POWERGRID will try to resolve at the earliest. Target date is November 2023.
Manipur State Sector			
5	132kV Imphal (State) – Karong	MSPCL and POWERGRID	<ul style="list-style-type: none"> MSPCL informed that diversion work is not completed due to RoW issue in the line. MSPCL requested NERTS to lay the OPGW on the existing line

SN.	Link name	Utilities	As per 25 th NETeST
			<p>and gave permission to carry out the work.</p> <ul style="list-style-type: none"> ▪ NERTS informed that work has already been completed up to the diversion portion. ▪ Target date for completion of link is September -2023.

The Sub-Committee noted as above.

Action: SLDC, Meghalaya, POWERTEL, POWERGRID, NERLDC & NERPC

B.3 Status and details of OPGW projects approved in 17th TCC/RPC meeting:

A. Additional Communication Scheme: Status as per 25th NETeST meeting.

Sl. No.	Lines	Target date	OPGW Stringing	Equipment Installation
1	132 kV Silchar - Hailakandi (Part of line)	August 2023.	Stringing Completed.	Material Delivered
2	132 kV Roing – Pasighat	January 2023.	Completed till pile foundation location.	Powered Up.
3	132 kV Roing – Tezu	January 2023.	Completed. (73/73) kM	Powered Up.
4	132 kV Tezu – Namsai	January 2023.	Stringing of 96/96 kM is completed	Powered Up.
5	132 kV Tuirial – Kolasib	November 2023	Tower profile detail provided by Mizoram was incorrect. POWERGRID has awarded contact for carrying out the survey.	Material Delivered
6	400 kV Balipara – Kameng	July 2023	Completed	Installed.

7	400 kV Bongaigoan – Killing (Byrnihat)	September 2023	Stringing of 202/202 km completed.	Material Delivered
8	400 kV Silchar – Killing (Byrnihat)	October 2023	Stringing of 150/216 kM is completed. WIP	Material Delivered

DD, NERPC instructed POWERGRID to expedite the installation of FOTE as materials are already delivered at site and installation of FOTE does not take much time. The commissioning of links is pending for more than three months for lack of installation of FOTE which could have been avoided.

The Sub-Committee noted as above.

Action: POWERGRID.

B. Reliable Communication Scheme (old ULDC replacement project):

The updated status is attached in **Annexure B.3b.**

The Sub-Committee noted as above.

Action: POWERGRID.

B.4 Selected cases of Sub-stations for rectification of corresponding data/communication related issues:

Status as per 24th NETeST.

Utility	Station	Requirement	Status as per 24 th NETeST
NEEPCO	Rangana di HEP	Second Channel via Pare-Chimpu	<ul style="list-style-type: none"> Link is configured by PGCIL Successful testing between NERLDC and RHEP on 18th May 2023. NEEPCO is requested to arrange support from SAS OEM, as to successfully implement the redundant channel, IP parameters of one of SAS gateway will be changed.

Deliberation of the sub-Committee:

Utility	Station	Requirement	Remarks
NEEPCO	Ranganadi	• Second Channel	• NERLDC will share IP parameters

Utility	Station	Requirement	Remarks
	HEP	via Pare-Chimpu	to RHEP for early execution of the work. • NEEPCO has taken up the matter with OEM

The Sub-Committee noted as above.

Action: NEEPCO & NERLDC

B.5 Integration of Dikshi HEP real time data and pending Voice communication:

M/s Devi Energies had earlier informed that due to bandwidth and some technical limitations in VSAT link availed by it, the alternate arrangement for PLCC system has been made which will have provision for speech/data/protection. It was mentioned that installation and commissioning of PLCC will be completed by May 2021.

As per 21st NETeST meeting, NERPC informed the forum that M/s Devi Energies has committed vide e-mail that it will complete the associated works by January-2022. Further, the forum decided that if M/s Devi Energies are not able to complete the work by January-2022, then DoP-Arunachal Pradesh should take strong action against M/s Devi Energies which may include restricting their generation till works are completed.

As per 22nd NETeST meeting, M/s Devi Energies intimated to the forum through e-mail that all associated works will be completed by June 2022.

As per 23rd NETeST meeting, DoP-Arunachal Pradesh informed that PLCC panel at Khupi for the erstwhile 132kV Balipara – Khupi will be shifted to Tenga and one (1) out of the two (2) new panels at Tenga will be shifted to Khupi. Thereafter, PLCC for 132kV Balipara-Tenga and 132kV Tenga-Khupi shall be operational. It was assured that the above works along with data reporting to respective SCADA system shall be completed by Aug'22.

During 24th NETeST meeting, forum requested DoP, Ar. Pradesh to take up the issue with M/s Devi energy and resolve at the earliest as this is very long pending issue.

Deliberation of the sub-Committee:

DoP, Arunachal Pradesh informed that Devi Energies Pvt. Ltd. has purchased PLCC panel for locations Dikhsi, Khupi and Balipara, which are delivered at sites but these PLCC panels are not compatible with PLCC panels present in Khupi and Balipara.

Therefore, integration is held up at sites. The forum requested DoP, Arunachal Pradesh to resolve the matter bilaterally with M/s Devi Energies.

The Sub-Committee noted as above.

Action: DoP, Arunachal Pradesh

B.6 Automatic Generation Control (AGC) in Indian Grid

Station Name	Background	Status as per 24th NETeST Meeting
BgTPP	Unit-2 needs to be integrated.	Configuration done in all units.
AGBPP (Kathalg)	<p>OEM visits was envisaged as per following –</p> <ul style="list-style-type: none"> • Some units are of Mitsubishi make which require team from Japan to visit plant. • Other units are of GE-make and BHEL-make 	<ul style="list-style-type: none"> • NEEPCO informed the forum that Mitsubishi has submitted the offer for necessary works. NEEPCO has also issued LC to M/s Mitsubishi, which is yet to confirm the same. Once Mitsubishi confirms the same, they will visit plant to carry out the work. The proposal is submitted to NEEPCO board, which is yet to be approved by competent authority. • NEEPCO informed the forum that proposal for AGC implementation in 02 nos. of BHEL&GE make GTS is approved by NEEPCO board. Procurement of required materials is under process.
Doyang	NEEPCO may update the status	<ul style="list-style-type: none"> • NEEPCO raised the concerned that R&M of DHEP will increase the tariff of plant as it is a relay-based plant. NEEPCO is still under internal discussion and will update the status in next NeTEST meeting. • Compensation will be given to plant as per Central Electricity Regulatory Commission (Ancillary Services) Regulations, 2022. • NEEPCO can follow the detailed procedure laid by Grid-India also. (Attached as Annexure B6). • NEEPCO may update following:

	<ul style="list-style-type: none"> • When will there DCS will be upgraded? • For AGC, one RTU is required to be installed which will communicate with DCS. Thus, requirement of whole station in SAS is not understandable.
--	---

Deliberation of the sub-Committee:

Status as updated in the 25th NETeST Meeting

Station Name	Background	Status as per 25 th NETeST Meeting
BgTPP	Unit-2 needs to be integrated.	Configuration done in all units.
AGBPP (Kathalguri)	<p>OEM visits was envisaged as per following –</p> <ul style="list-style-type: none"> • Some units are of Mitsubishi make which require team from Japan to visit plant. • Other units are of GE-make and BHEL-make 	<p>Four number of Mitsubishi-make GTs:</p> <ul style="list-style-type: none"> • NEEPCO informed the forum that Mitsubishi has submitted the offer for necessary works. NEEPCO has also issued LC to M/s Mitsubishi, which was expired and NEEPCO will extend the LC. Once Mitsubishi confirms the same, they will visit plant to carry out the work. Target for the same will be shared accordingly. <p>Two number of BHEL & GE-make GTs:</p> <ul style="list-style-type: none"> • NEEPCO informed the forum that software and hardware related work of DCS are completed. • Technical specification (TS) for RTU of AGC is under preparation and it will be put under procurement once TS is prepared. • Target date: March 2024
Doyang	NEEPCO may update the status	<ul style="list-style-type: none"> • NEEPCO informed that technical specification is under preparation for AGC implementation along with SCADA upgrade of station.
Kopili Stage - 2	25 MW	<ul style="list-style-type: none"> • AGC is installed at the plant. All software and hardware works are also completed. AGC can be taken into service after all small issues get resolved for re-commissioning.
Kopili	100 MW	<ul style="list-style-type: none"> • Under renovation AGC system is also getting installed. • One Machine is expected to come into service by July'23.

Station Name	Background	Status as per 25 th NETeST Meeting
		<ul style="list-style-type: none"> Second Machine is expected to come into service by August'23.

The Sub-Committee noted as above.

Action: NEEPCO

B.7 Pending issues of State Utilities of NER:

The presentation on telemetry status for the month of April 2023 is attached as **Annexure B7**.

The utility-wise discussion points for telemetry issues are listed in table below.

Utility	Pending issues	Status as updated in the 24 th NETeST meeting
Assam	SAS upgradation related works may be updated.	<ul style="list-style-type: none"> Assam-SLDC will submit the status by March'23 to NERPC and NERLDC.
Tripura	Dhalabil	<ul style="list-style-type: none"> TSECL requested PGCIL to extend support for restoration of systems over GPRS. NERTS agreed for the same.
	Ambassa	
	Sabroom, Satchand	
	13 stations not covered under NER-FO expansion project	
Manipur	Churachandpur, Kongba and Kakching	<ul style="list-style-type: none"> Work will be completed by August 2022.
	Elangkhangpokpi, Thanlon, 132kV Thoubal	<ul style="list-style-type: none"> Board approval is required for DPR preparation.
Nagaland	Kiphire	<ul style="list-style-type: none"> Meluri-Kohima line is still under diversion due to road construction work. PLCC will be restored once line is restored over new towers.
Mizoram	Luangmual	<ul style="list-style-type: none"> PE&D-Mizoram informed that all isolators are
	Zuangtui	

Utility	Pending issues	Status as updated in the 24th NETeST meeting
	Kolasib	<p>manually operated and there is no auxiliary contact available for isolators.</p> <ul style="list-style-type: none"> • P&ED Mizoram will do survey of all isolator to understand the mechanism and way out to provide telemetry.
Arunachal Pradesh	VSAT installation and other issues	<ul style="list-style-type: none"> • It has been observed that UPS supply is not extended to VSAT MODEMs installed due to which there is interruption in data whenever power supply fails in the concerned substations i.e. Pasighat, Deomali, Along, Khupi and Bhalukpong. • DoP, Arunachal is formulating the proposal to buy UPS for each station to cater for the power supply to VSAT equipment. • DoP, Arunachal Pradesh informed that joint visit with M/s GE is required at 132 kV Daporijo S/s to investigate the extent of damage to RTU after fire incident. M/s GE and DoP-Arunachal Pradesh agreed to visit by 29th July 2022. • DoP, Arunachal and GE are working on proposal for replacement of faulty cards. • Pasighat: Power supply to RTU is interrupted after the malfunction of 48/110V DC charger of substation. DoP, Arunachal is working to replacement of 48/110V DC charger.

Deliberation of the sub-Committee:

Status as updated in the 25th NETeST Meeting

Utility	Pending issues	Remarks
Assam	SAS upgradation related works may be updated.	<ul style="list-style-type: none"> • NERLDC will share the format for compiling the data. • Assam-SLDC will submit the status by June'23 to NERPC and NERLDC.
Tripura	Dhalabil, Ambassa	<ul style="list-style-type: none"> • TSECL requested PGCIL to extend support

Utility	Pending issues	Remarks
	Sabroom, Satchand 13 stations not covered under NER-FO expansion project	for restoration of systems over GPRS. NERTS agreed for the same. • TSECL also requested NERPSIP to complete the links at the earliest.
Manipur	Churachandpur, Kongba and Kakching	• MSPCL informed that work is under progress to resolve the issues but the same is hampered due to law-and-order issue in the state. Work will be completed in due time.
	Elangkhangpokpi, Thanlon, 132kV Thoubal	• MSPCL has proposed the purchase of RTUs under PSDF.
Nagaland	Kiphire	• Meluri-Kohima line is still under diversion due to road construction work. PLCC is restored, DoP will visit the station to restore the data at the earliest.
Mizoram	Luangmual	• PE&D-Mizoram informed that survey for restoration of isolator data has been done and proposal to restore the data will be submitted sooner.
	Zuangtui	
	Kolasib	
Arunachal Pradesh	VSAT installation and other issues	<p>UPS installation for VSAT equipment:</p> <ul style="list-style-type: none"> • Purchase order for procurement of UPS has been placed for following locations: Along, Daporijo, Deomali and Pasighat. Same will be installed in due time. <p>RTU failure at Daporijo:</p> <ul style="list-style-type: none"> • DoP, Arunachal Pradesh informed that joint visit with M/s GE is completed at 132 kV Daporijo S/s to investigate the extent of damage to RTU after fire incident. M/s GE is yet to submit the budgetary offer. • M/s GE T&D asked DoP-AR to confirm on submission of Techno-commercial offer. Accordingly, work will be started. <p>Power Supply issue at Pasighat:</p> <ul style="list-style-type: none"> • 48V to 110V DC Converter is faulty, same has been purchased and issue will be resolved within June'23.

The Sub-Committee noted as above.

Action: All SLDCs, NERLDC & NERPC.

B.8 Feasibility to connect Lekhi Substation over Fiber-Optic Network:

As per 24th NETeST meeting, Sr. GM, NERTS informed the forum that currently Valiant make PDH is installed at Lekhi S/s, with one optical card which is providing

facility to connect RTU over Ethernet based system. SDH equipment will also be installed which will be diverted from Monarchak.

Deliberation of the sub-Committee:

POWERGRID informed the forum that SDH equipment has been diverted from Monarchak and the same shall be installed by 15th June, 2023. POWERGRID requested DoP, Arunachal Pradesh to provide space for installation & they have agreed to provide the same. POWERGRID also informed that due to DCPS issue, presently they were using DC convertor. DoP, Arunachal Pradesh agreed to look into the matter.

The Sub-Committee noted as above.

Action: DoP, Arunachal Pradesh & POWERGRID.

B.9 Integration of INDIGRID owned OPGW with ULDC network:

Under NER strengthening scheme, Indigrid (erstwhile Sterlite) has constructed following lines along with OPGW –

1. **132 kV R C Nagar – PK Bari (TSECL) D/c:** Will provide additional path between Agartala and PK Bari
2. **400 kV Silchar – Misa D/c:** Will provide additional link between south NER and North NER.
3. **132 kV BNC – Chimpu D/c:** Will provide additional path between Arunachal Pradesh and rest of NER.
4. **132 kV PK Bari (TSECL) – PK Bari (IGT):** Will provide secondary path for Indigrid Stations.

Feasibility to connect the above links with existing ULDC network needs to be explored for which it was requested to POWERGRID-NERTS and Indigrid to explore the possibility of utilization of the link as alternate path.

The status as per 24th NETeST meeting is given in *table* below:

Sl. No.	Description	As per 24th NETeST Meeting
1.	132 kV RC Nagar – PK Bari (TSECL)	<ul style="list-style-type: none"> • Indigrid will integrate the link over GE equipment between PK Bari and RC Nagar. Further, at RC Nagar ULDC equipment will be integrated with GE FOTE. SFPs will be provided by each utility as per the ownership of equipment (FOTE). The work will be completed by March'23.
2.	400 kV Silchar-	<ul style="list-style-type: none"> • Indigrid informed that after line restoration the

Sl. No.	Description	As per 24th NETeST Meeting
	Misa D/C	integration of ULDC FOTE and Indigrd owned FOTE will be done. SFPs will be provided by each utility as per the ownership of equipment (FOTE). The work will be completed by March'23.
3.	132 kV BNC – Chimpu D/C	<ul style="list-style-type: none"> The link is integrated with existing network of ULDC. For the time being, only 2 fibers have been utilized.
4.	132 kV PK Bari (TSECL) - PK Bari (IGT)	<ul style="list-style-type: none"> As the fiber is laid by NERPSIP, and ownership of fiber is with TSECL. Indigrd requested TSECL to provide 2 core fiber for integration of FOTE equipment at the both end. TSECL agreed to provide the fiber. Integration work will be completed by March'23.

Deliberation of the sub-Committee:

Status as updated in the 25th NETeST Meeting

SN	Description	As per 25th NETeST Meeting
1.	132 kV RC Nagar – PK Bari (TSECL)	<ul style="list-style-type: none"> Indigrd has integrated the link over GE equipment between PK Bari and RC Nagar. Further, at RC Nagar one attempt was made to integrate ULDC equipment (ECI make) with GE FOTE which was not successful. PGCIL informed that support of GE engineer is required to take second attempt in which Fibcom equipment will be integrated with GE. Indigrd and PGCIL are requested to take up the matter and close the matter at earliest.
2.	400 kV Silchar-Misa D/C	<ul style="list-style-type: none"> COMMTEL equipment has been integrated with ECI equipment. Thus, the connectivity is completed. Agenda to be dropped.
3.	132 kV BNC – Chimpu D/C	<ul style="list-style-type: none"> The link is integrated with existing network of ULDC. For the time being, only 2 fibers have been utilized. Agenda to be dropped.
4.	132 kV PK Bari (TSECL) - PK Bari (IGT)	<ul style="list-style-type: none"> Link depend on integration of ULDC equipment with GE as described in Sl. No. 1

The Sub-Committee noted as above.

Action: INDIGRID, M/s GE & POWERGRID

B.10 Non-reporting of telemetry data of APGCL owned generating stations:

The status of telemetry data of generating stations owned by Assam Power Generation Corporation Limited is summarized in the table given below:

Sl. No.	Name of Generating Station	Status of Telemetry data	Remarks
1.	LTPS (Lakwa Thermal Power Station)	<ul style="list-style-type: none"> All CB are reporting correctly except Unit – 6 132 kV CB, it is showing wrong status. All Isolators are reporting correctly. All HV side data of GT-5 (unit -5) are not reporting. 	
3.	NRPP (Namrup Replacement Power Project)	<ul style="list-style-type: none"> All digital and analog data are not reporting for GTG. 	For GTG all digital and analog data are not reporting because of the BCU (Bay Control Unit) of GTG bay is not functioning. It would be attended in next cool shutdown of GTG. Procurement of a new BCU for GTG Bay has already been initiated. Expected completion on December 2022.
4.	NTPS (Namrup Thermal Power Station)	<ul style="list-style-type: none"> All digital data (CB and Isolators) of units are reporting wrong status. 	
		<ul style="list-style-type: none"> Analog data of Unit 6 is not reporting. 	Unit is under shut-down from 22-06-2022.Hence, analog data is not reporting.
5.	Langpi Hydro Station	<ul style="list-style-type: none"> CB associated with units are not reporting wrong status. Analog data of unit-2 are not reporting. 	Telemetry work will be completed after completion of the major overhauling work of #2. Target date is 15 th May, 2023.

Sl. No.	Name of Generating Station	Status of Telemetry data	Remarks
		<ul style="list-style-type: none"> • CB of SST is reporting wrong value. • Isolators of Bus coupler and Sarusajai line 1 are not reporting. • Analog data of transmission lines and SST are not reporting. 	

Deliberation of the sub-Committee:

Member Secretary, NERPC advised NERLDC, APGCL and SLDC, Assam to resolve the issue jointly.

The Sub-Committee noted as above.

Action: NERLDC, APGCL and SLDC, Assam

Any other item:**Date and Venue of next NETeST Meeting:**

It is proposed to hold the 26th NETeST meeting of NERPC in the month of September 2023. The date & exact venue will be intimated in due course.

List of Participants in the 25th NETeST Meeting held on 25.05.2023

SN	Name & Designation	Organization	Contact No.
1	Sh. Dani Byai, JE (E), SLDC, AP	Ar. Pradesh	7085693297
2	Sh. Aniyang Tatung, JE (E), SLDC, AP	Ar. Pradesh	7005378029
3	Sh. Ashutosh Bhattacharya, DGM, AEGCL	Assam	9954106916
4	Sh. Rupjyoti Das, DM, AEGCL	Assam	9435097009
5	Sh. Devjyoti Patowary, DGM, AEGCL	Assam	9435591968
6	Sh. Himangshu Das, AGM, APGCL	Assam	9435477842
7	Smti. Jayela Wahrenbam, DM, MSPCL	Manipur	9856875084
8	Sh. D. J. Lyngdoh, EE (SM), MePTCL	Meghalaya	-
9	Sh. C. W. Chen, AEE (C&C), MePTCL	Meghalaya	9863093311
10	Sh. S. W. Khyriem, AEE (CSD), MePGCL	Meghalaya	8787346704
11	Sh. R. Lalchawisanga, SDO (TC), Mizoram	Mizoram	7640954240
12	Sh. P. Tiakaba Yimchunger, JE, SLDC Nagaland	Nagaland	8974020151
13	Sh. Joypal Roy, GM (E/M)	NEEPCO	8837200069
14	Sh. N. Roy, ED	NERLDC	9869080265
15	Sh. S.P.Barnwal, Sr.GM (SL)	NERLDC	9433041812
16	Sh. Akhil Singhal, Ch. Manager (Logistic)	NERLDC	9650598187
17	Sh. Sakaldeep, A.M (SL)	NERLDC	9774528218
18	Sh. Paominlal DOUNGEL, (SL)	NERLDC	8575778425
19	Sh. R. Haribabu, DGM (RTAMC)	PGCIL	9445021006
20	Sh. A. Acharya, CM (Comm)	PGCIL	9402106974
21	Sh. Kamlesh Baishya, Asst. Mgr (ULDC)	PGCIL	9859723132
22	Sh. P. Johnny Singh, JE (ULDC)	PGCIL	9435303572
	NO REPRESENTATIVE	NHPC	
	NO REPRESENTATIVE	OTPC	-
	NO REPRESENTATIVE	NTPC	-
	NO REPRESENTATIVE	INDIGRID	-
23	Sh. Pankaj Kr. Das, Sr.GM	NERPSIP	9910378130
24	Sh. Abhilash A. A, Asst. Mgr	NERPSIP	9600160276
25	Sh. Pranjal Das, Asst. Mgr	NERPSIP	8473811643
26	Sh. Tamal Bhattachya	GE	8436062436
27	Sh. K. B. Jagtap, Member Secretary	NERPC	9436163419
28	Sh. Sadiq Imam, DD	NERPC	7004133772
29	Sh. Shaishav Ranjan, DD	NERPC	8787892650
30	Sh. Rajib Das, AD-I	NERPC	-
Joined Via Online			
1	Smti. Shampa Sen, Sr. Mgr, TSECL	Tripura	9436120263
2	Sh. H. S. Kausal, Sr. GM, CTUIL	CTUIL	-
3	Sh. Shiv Kumar Gupta, Sr. DGM, CTUIL	CTUIL	-
4	Sh. Kaushal Suman, Manager, CTUIL	CTUIL	7042396702

CYBER SECURITY MEASURES IMPLEMENTATION STATUS FOR NER SLDCs (AS ON 19.05.2023)

SN	Cyber Security Measures	Arunachal Pradesh	Assam	Manipur	Meghalaya	Mizoram	Nagaland	Tripura
1	Preparation and approval of Cyber Crisis Management Plan (CCMP) for SLDCs	Final CCMP approved by CERT-In with comments for incorporation.	Final CCMP approved by CERT-In with comments for incorporation.	Final CCMP approved by CERT-In with comments for incorporation.	Final CCMP approved by CERT-In with comments for incorporation.	Final CCMP approved by CERT-In with comments for incorporation.	Final CCMP approved by CERT-In with comments for incorporation.	Final CCMP approved by CERT-In with comments for incorporation.
2	Implementation status of Information Security Management System (ISMS) i.e., ISO 27001 and certification audit for ISO-27001	Contract awarded to a Certifying Agency. Visit planned in June.	Implemented. Assam SLDC has received certification for ISMS (ISO 27001: 2013) on 09.07.22. 1st Surveillance Audit scheduled in July'23 .	LOA issued to CDAC, Hyderabad on 3rd Nov'21 for Implementation of ISMS (ISO-27001). Work is going on for implementation of ISMS	Implemented. Meghalaya SLDC has received certification for ISMS (ISO 27001: 2013) on 09.07.22. 1st Surveillance Audit scheduled in June'23 .	Budgetary offers had been collected from various CERT-IN empanelled vendors and were processed for approval of Management. They have asked for resubmission of the proposal. Now, DPR has been prepared and proposal has been submitted to Management for approving C-DAC on nomination basis. Approval awaited.	In the process of implementing Security policies as recommended by Certifying agency.	Contract has been awarded to Certifying Agency and implementation is in progress.
3	Status of VA-PT on OT systems	Done for FY 22-23.	Done for FY 22-23.	Done for FY 23-24.	Done for FY 22-23.	Done for FY 23-24.	Done for FY 22-23.	Done for FY 23-24.
	i) Date of Last VA-PT (OT):	24/03/2023- 28/03/2023	17/02/2023 - 21/02/2023	03/04/2023-05/04/2023	09/03/2023- 13/03/2023	04/04/2023- 11/04/2023	20/03/2023- 22/03/2023	19/04/2023- 20/04/2023.
	Submission of latest VA-PT report carried out on OT systems of SLDC for onward submission to MoP							
ii) Due date for Next Audit / Plan for next audit (OT) :	24-03-2024	17-02-2024	03-04-2024	09-03-2024	04-04-2024	20-03-2024	19-04-2024	
4	Status of VA-PT on IT systems (to be done once in every six months)	Contract awarded to a Certifying Agency. Visit planned in June'23 .	Last VAPT completed on 22.02.2023 ; reports received.	Phase -1 of VAPT for IT systems has been completed. Phase-2 is scheduled in June'23.	Last VAPT completed in March-2023 ; reports awaited.	Budgetary offers had been collected from various CERT-IN empanelled vendors and were processed for approval of Management. They have asked for resubmission of the proposal. Now, DPR has been prepared and proposal has been submitted to Management for approving C-DAC on nomination basis. Approval awaited.	Phase -1 of VAPT for IT systems has been completed. Phase-2 is scheduled in the last week of May'23.	Last VAPT completed in 2023 ; reports awaited.
5	Notification of IT & OT systems at SLDCs as Critical Information Infrastructure (CII)	Final revised CII document has been submitted to NCIIPC after incorporation of comments on 19.05.2023.	Identified Systems of SLDC, Assam have been declared as CII by NCIIPC. Notification of CII as Protected Systems shall be issued by State Govt.	Final revised CII document has been submitted to NCIIPC after incorporation of comments on 20.02.2023.	Identified Systems of SLDC, Meghalaya have been declared as CII by NCIIPC. Notification of CII as Protected Systems has been issued by State Govt. on 18.04.2022.	Final revised CII document had been submitted to NCIIPC after incorporation of comments on 06.06.2022.	Identified Systems of SLDC, Nagaland have been declared as CII by NCIIPC. Notification of CII as Protected Systems still pending with the State Govt.	Resubmission of CII documents after incorporation of comments received from NCIIPC vide email dtd. 23.06.22 is pending.
	Updated Completion Timeline by SLDC**:							
6	Compliance of advisories from CERT-In, NCIIPC & other statutory agencies.	Being complied for OT	Being complied	Being complied	Being complied	Being complied	Being complied	Being complied
i	To be updated in Portal for monthly compliance by 10th of every month.	Not updated in the portal	Being Updated in Portal	Being Updated in Portal	Being Updated in Portal	Being Updated in Portal	Being Updated in Portal	Being Updated in Portal
ii	For CERT-In weekly advisories to be complied within 5 days: To be uploaded in the portal after completion.	Being Updated in Portal	Being Updated in Portal	Being Updated in Portal	Being Updated in Portal	Being Updated in Portal	Being Updated in Portal	Being Updated in Portal

CYBER SECURITY MEASURES IMPLEMENTATION STATUS FOR NER SLDCs (AS ON 19.05.2023)

SN	Cyber Security Measures	Arunachal Pradesh	Assam	Manipur	Meghalaya	Mizoram	Nagaland	Tripura
ii	Compliance of advisories from Cyber Swachhta Kendra (CSK)	Being Resolved. No new alerts.	Being Resolved. No new alerts.	Being Resolved. No new alerts.	Being Resolved. No new alerts.	Being Resolved. No new alerts.	Being Resolved. No new alerts.	Being Resolved. No new alerts.
7	Status of Nomination of CISO:	Done	Done	Done	Done	Done	Done	Done
	Alternate CISO (if any):	Yes	Yes	Yes	Yes	Yes	Yes	Yes
8	Cyber Security Certification: (Training attended)	No	Yes. Basic level training and certification on Cyber Security for Power Sector Professionals completed by officials (2 Officials) of IT/SCADA department.	Yes. (2 Officials)	Yes. (10 officials undergone Basic level certification course from NPTI)	Yes (1 Official trained in Two Weeks Basic Level Training and Certification Program on Cyber Security)	No	No
9	IT - OT Integration:	Not present	Not present	Not present	Not present	Not present	Not present	Not present

Communication Audit Plan-NER

SN	Station Name	Location
1	SLDC Arunachal Pradesh	Arunachal Pradesh
2	Pare (NEEPCO)	
3	Ranganadi (NEEPCO)	
4	SLDC Assam	Assam
5	Bongaigaon (State)	
6	Bongaigaon (PGCIL)	
7	Salakati (PGCIL)	
8	Rangia (State)	
9	Kathalguri (NEEPCO)	
10	Tinsukia (State)	
11	Mariani (PGCIL)	
12	Silchar (PGCIL)	
13	Badarpur (PGCIL)	
14	SLDC Manipur	Manipur
15	Loktak (NHPC)	
16	Imphal (PGCIL)	
17	SLDC Meghalaya	Meghalaya
18	NERLDC	
19	Kheliriat (PGCIL)	
20	SLDC Mizoram	Mizoram
21	Aizawl (PGCIL)	
22	Melriat (PGCIL)	
23	Lungmual (State)	
24	Zuangtui (State)	
25	SLDC Nagaland	Nagaland
26	Doyang (NEEPCO)	
27	Dimapur (PGCIL)	
28	Dimapur (State)	
29	Kohima (State)	
30	New Kohima (KMTL)	Tripura
31	SLDC Tripura	
32	Agartala (State)	
33	Kumarghat (PGCIL)	
34	SM Nagar (State)	
35	SM Nagar (Indigrid)	
36	Palatana (OTPC)	

REGIONAL COMMUNICATION AUDIT REPORT
--

General Information:		
-----------------------------	--	--

1	Substation Name	
2	SS Voltage level	
3	Date of commissioning of the substation	
4	Region & State / Auditee	
5	Audit Date	
6	Name of the Utility which owns the SS	

Details of Audit Team Members :			
--	--	--	--

SL	Name	Designation	Organization
1			
2			
3			
4			

Attached Documents, if any		
-----------------------------------	--	--

SL	Name of the document	Original / Signed / Copy
1		
2		
3		
4		
5		
6		
7		
8		
9		
10		
11		
12		
13		
14		
15		
16		
17		

Communication Channels and Equipments Audit Format

(A) List of channels in usage for data (64 kbps, 104, PMU, VC, 101) / Voice / Protection circuits / Others :

Sl	Description (64 kbps, 104, PMU, VC, 101) / Voice / Protection circuits / Others)	Source	Destination	Channel Routing	Ownership details of terminal equipment / Links
1					
2					
3					
4					
5					
6					
7					
8					

(B) List of terminal communication equipments :

Sl	Name of Station	Equipment Type (SDH / PDH / Radio / VSAT / EPABX)	Make / Model	Ownership
1				
2				
3				
4				
5				
6				
7				
8				

(C) Communication System Details :

I. SDH Equipment

(1) Card Details :

Slot No	IP Address & Path / Direction Name	Card Details	Place a ✓ mark if on usage, else Write as "Spare"	Whether Card is healthy / Faulty ? (H / F)	Cards Redundancy available (Yes / No)	Power Supply Card / Optical Card (Yes / No)	MSP configured ? (Yes / No)	Action Plan for faulty cards	Other Information, if any
1									
2									
3									
And so on									

(2) Whether equipment is time synchronized : Yes / No

If Yes, how is it being done ?

(3) Failures during last Fin. year / since last Audit :

Particulars	Number of failures of Card / Power Supply	Reason for failures	Measures taken for rectification
Card		(i) (ii) (iii)	(i) (ii) (iii)
Power Supply		(i) (ii) (iii)	(i) (ii) (iii)

(4) Configuration of the Node :

Name of Equipment	Number of Nodes	Number of directions	Name of Directions	Number of links down, with details	Details of corrective action, if any, taken

(5) Preventive maintenance schedule and its compliance :

Date of Last Preventive maintenance	Maintenance carried out as per schedule ? (Yes / No)	Whether all the defects have been attended ? (Yes / No) Give details

II. PDH Equipment

(1) Card Details :

Slot No	IP Address	Card Details	Place a ✓ mark if on usage, else Write as "Spare"	Whether Card is healthy / Faulty ? (H / F)	Cards Redundancy available (Yes / No)	Power Supply Card / Optical Card (Yes / No)	MSP configured ? (Yes / No)	Action Plan for faulty cards	Other Information, if any
1									
2									
3									
And so on									

(2) Whether equipment is time synchronized : Yes / No

If Yes, how is it being done ?	

(3) Failures during last Fin. year / since last Audit :

Particulars	Number of failures of Card / Power Supply	Reason for failures	Measures taken for rectification
Card		(i) (ii) (iii)	(i) (ii) (iii)
Power Supply		(i) (ii) (iii)	(i) (ii) (iii)

(4) Configuration of the Node :

Name of Equipment	Number of Nodes	Number of directions	Name of Directions	Number of links down, with details	Details of corrective action, if any, taken

(5) Preventive maintenance schedule and its compliance :

Date of Last Preventive maintenance	Maintenance carried out as per schedule ? (Yes / No)	Whether all the defects have been attended ? (Yes / No) Give details

III. OPGW / Optical Fibre Details

Number of Directions	Name of Direction	No. of Pairs	No. of Fibers used	No. of spare & healthy Fibers	Unarmoured cable laid within PVC/Hume duct pipe ?	Fibre Count in OPGW ? Whether matching with Approach cable to FODP ?	Overall Optical Fibre Path Attenuation (dB/km)	Power Received	Conformation to Compliance of CEA Standards

IV. Healthiness of Auxiliary System :

(1) Details of 2 independent Power Sources :

Source	Commissioning Date	Battery Back up (Hour)	Battery capacity (AH)	Supply Voltage (V)	Healthiness of Battery (Yes / No)	Make of Charger	Charger Capacity (A)	Periodicity of Maintenance Schedule	Date of Last 2 Actual Maintenance carried out	Remarks
1										
2										

(2) Conformation to Compliance of CEA Standards :

V. Healthiness of Earthing of each equipment :

Sl	Equipment	Status on Healthiness of Earthing

VI. Details of Voice communication available between Sub-station and Control Centre :

Sl	Voice communication (Sub-station - Control Centre)	Status on Healthiness of Voice communication	Healthiness of air-conditioning of communication room as per OEM recommendation

VII. PLCC Details :

Number of Panels	Make and Model	Direction	Frequency (Tx & Rx) KHz	Status on Healthiness	Last preventive maintenance		Details of defects, if any, attended	Status of Availability of Spares	Conformation to Compliance of CEA Standards
					Schedule	Actual			

VIII. Radio Communication Details :

Number of Equipments	Make and Model	Status on Healthiness	Last preventive maintenance		Details of defects, if any, attended	Status of Availability of Spares	Conformation to Compliance of CEA Standards
			Schedule	Actual			

IX. Data Retention : (i) **Earliest Date of availability of data :** _____
 (ii) **Historical data availability :** _____ days.

X. Control Command Delay : (i) **Time delay in seconds from Control Centre for SCADA :** _____ Seconds
 (ii) **Time delay in seconds from Control Centre for WAMS :** _____ Seconds

XI. Wide Band Network : (i) **Absolute channel delay in protection applications :** _____ ms
 (ii) **Channel delay asymmetry in protection applications :** _____ ms
 (iii) **Switching Time delay to alternate path/route during failure of one path :** _____ ms

XII. Any other information :

**Audit Team Member
NERPC**

**Audit Team Member
Co-Ordinator**

**Audit Team Member
PGCIL (Internal / External)**

**Audit Team Member
State (Internal / External)**

North Eastern Regional Power Committee, Shillong

Procedure on Outage Planning for Communication System -NER

1. Introduction:

The communication needs of the power sector have amplified significantly with the increase in the size and complexity of the grid. Communication is also a key pre-requisite for the efficient monitoring, operation and control of power system. Communication systems are vital to facilitate secure, reliable and economic operation of the grid. For integrated operation of the Grid, uninterrupted availability of the real time data of various Power System elements assumes utmost importance.

2. Regulatory Provisions with respect to Outage Planning for Communication System :

- 2.1 Communication System for inter-State transmission of electricity Regulations, 2017
- 2.2 Technical Standards for Communication System in Power System Operations Regulations, 2020

3. Objective :

- 3.1 Regulation 7.3 of Central Electricity Regulatory Commission (Communication System for inter-State transmission of electricity) Regulations, 2017 states

7.3 Role of National Power Committee (NPC) and Regional Power Committee (RPC) :

.....

(iv) The RPC Secretariat shall be responsible for outage planning for communication system in its region. RPC Secretariat shall process outage planning such that uninterrupted communication system is ensured.

.....

- 3.2 Regulation 10 Central Electricity Authority (Technical Standards for Communication System in Power System Operations) Regulations, 2020 notified on 27.02.2020 states

10. Outage planning : Monthly outage shall be planned and got approved by the owner of communication equipment in the concerned regional power committee, as per detailed procedure finalised by the respective regional power committee.

- 3.3 The objective of this Procedure on Outage Planning of communication System is to carry out outage planning for communication system in NER such that uninterrupted communication system is ensured.

4. Scope and applicability :

4.1 The scope and applicability as per Central Electricity Regulatory Commission (Communication System for inter-State transmission of electricity) Regulations, 2017 is given below :

.....

5. Scope and Applicability :

(i) *These regulations shall apply to the communication infrastructure to be used for data communication and tele-protection for the power system at National, Regional and inter-State level and shall also include the power system at the State level till appropriate regulation on Communication is framed by the respective State Electricity Regulatory Commissions.*

(ii) *All Users, SLDCs, RLDCs, NLDC, CEA, CTU, STUs, RPCs, REMC, FSP and Power Exchanges shall abide by the principles and procedure as applicable to them in accordance with these regulations.*

.....

4.2 The applicability as given in Central Electricity Authority (Technical Standards for Communication System in Power System Operations) Regulations, 2020 notified on 27.02.2020 is given below :

.....

3. Application - These regulations shall apply to all the users, National Load Despatch Centre, Regional Load Despatch Centres, State Load Despatch Centres, Load Despatch Centres of distribution licensee, Central Transmission Utility, State Transmission Utilities, Regional Power Committees, Renewable Energy Management Centres, forecasting service provider and power exchanges.

.....

4.3 All concerned entities stated above would coordinate with NERPC for outage planning of communication System.

4.4 Communication Outage Coordination will be limited to the following system :

(i) ISTS Communication System including ISGS

(ii) Intra-state Communication System being utilised for ISTS Communication

(iii) Any other system agreed by the forum

4.5 Communication Equipment/link within the scope of the Procedure would include :

(i) Optic Fibre links

(ii) Any other link being used for ISTS communication

(iii) ICCP links between Main & Backup RLDCs, Main & Backup SLDCs & Main & Backup NLDC

(iv) VC links between LDCs

(v) Inter regional AGC links

(vi) SPS Links

- (vii) Tele-Protection
- (viii) AMR
- (ix) SDH & PDH
- (x) DCPC
- (xi) RTU
- (xii) DTPCs
- (viii) Battery Banks and Charging Equipment
- (ix) EPABX
- (x) Any other equipment/link agreed by the forum

Note : PLCC would not be included, if the link is not used for SCADA Data.

5. Procedure on Monthly Outage Planning of Communication System – NER :

- (i) **Each concerned Entity would nominate Nodal Officer/ Alternate Nodal Officer** along-with details to the Outage Planning of Communication System group along-with designation, Mobile number, email ID, Phone number etc. Nodal Officer / Alternate Nodal Officer would interact internally and would be single point contact for outage planning with NERPC / NERLDC.
- (ii) The outage proposal of the communication equipment shall be **submitted in the prescribed format** by mail only (attached as **Annexure – I**). The type of services (viz. data, voice, protection etc.) being affected / not affected may also be mentioned under col No.8 in the format. If there is no interruption to any service, the precautions and actions (like redundant path) being taken to ensure data, voice etc availability would also be mentioned in col No.8, which facilitates to avoid simultaneous outage for the same service(s).
- (iii) Users / Owners of the communication equipment will furnish their monthly outage proposal in respect of their equipment through the software for Outage Planning of Communication System, which will be considered to be developed by NERLDC for the usage by NERLDC, NERPC & Users / Owners of the communication equipments.
- (iv) Till the software application is developed by NERLDC, the Users / Owners of the communication equipments will furnish their monthly outage proposal in respect of their equipments in the prescribed (in excel format only). Modification of this format is not allowed. However, suggestion for improving the format is solicited. Outage proposals not in the format or through Fax/PDF etc will be rejected.
- (v) **RPC will consolidate the list of outage proposals** received from various Users / Owners of the communication equipments and release the list by 15th of every month.
- (vi) **Communication outages affecting other regions would be coordinated by NERLDC through NLDC.**

- (vii) **A meeting will be conducted every month during the middle of month** normally through VC to discuss and approve / dispose the proposed list of outages pertaining to communication links / equipments. **The date of VC will be informed by mail during the 1st week of the month.**
- (viii) In the VC, the system constraints pertaining to the outage of communication equipments, if any, will be discussed and the outage proposals will be approved / revised / disposed in the VC. Therefore, all the Users / Owners of the communication equipments shall attend the VC without fail. It is requested that the Nodal Officers who do not have VC facility may join in the nearby VC available with State SLDC / PGCIL.
- (ix) **The final approved list of communication equipments will be released by NERPC after the VC is completed.**
- (x) **In case of any emergency outage requirement of communication equipments, Users / Owners may directly apply to NERLDC on D-1 basis.**
- (xi) Even though outages of communication equipments are approved in the VC, Concerned **entities will also confirm availing of approved outages or dropping of the approved outages of communication equipments / links on D-3 day** to NERLDC.
- (xii) After the communication outage application is put in place, the **Constituents will take code from NERLDC** before availing the planned outage and before restoration. In the interim period, NERLDC may take appropriate call.
- (xiii) All Users / Owners of the communication equipments **will submit their deviation report by 10th of the month** to NERPC / NERLDC in respect of the outages of communication links / equipments availed during the previous month as per the format attached as **Annexure – I.**
- (xiv) All Users / Owners of the communication equipments **will submit their report on planned / forced / other outage of communication links / equipments along with the above said deviation report to NERPC / NERLDC** as per the format attached as **Annexure – I.**

Introduction of MPLS Technology in Indian Power Sector

Why migrate from SDH?

- End of life of SDH technology, will be obsolete soon, (Last development- 2000).
- SDH is having fixed bandwidth channels for various communication applications and not as per use.
- Bandwidth efficiency is not as high as MPLS.
- SDH OEMs are advising to go for new technologies as globally chip production of SDH equipment is reduced and thus maintenance of SDH equipment is getting difficult.
- Trend in technology change, Globally Power Utilities are migrating from conventional SDH (circuit switching) to MPLS (Packet Switch Network) such as Energinet Denmark, ORES UK, Austin Energy USA etc.
- A platform needed for growth using flexible protocols to support future applications.
- High demand IP packet based applications.

Why go for MPLS?

- Adaptability of Multiple protocol applications obviate the use of protocol converters.
- MPLS is Packet Switch Network technology, no reservation of data bandwidth (BW), high BW efficiency.
- QoS based services.
- Long term availability of spares as new technology.
- Various Class of Service available for different applications data.
- Different services can be mapped in different VPNs through single physical port.
- Supports both L2 and L3 network.
- Higher Cyber Security due to use of VPN, easy deployment of Firewall.

Table: Comparison of Various Technologies

Factors	SDH	IP-MPLS	TP-MPLS
Channel routing	Static user defined	Dynamic network defined	Static user defined
Channel directions	Bidirectional (same To-Fro paths)	Unidirectional (different To-Fro paths)	Bidirectional (same To-Fro paths)
Channel Supervision	End to end	Link wise	End to end
Data channel	Deterministic	Non-deterministic (without special measures)	Nearly deterministic (if network planned properly)
NMS & Control Panel	Same	Different	Same
Resilience (Protection mechanism switching)	<50ms	>50ms	<50ms
Latency	0.06ms	> 0.06 ms	0.02ms
Bandwidth efficiency	Fixed BW	Efficient	Efficient
CoS choice	same class of service,	Multiple Choice for different application	Pre defined choice can be made for different application.
QoS	Determined by BER	Determined by Packet loss	Determined by Packet loss

Present ISTS Communication Network

- Approx 65000 Km of OPGW.
- Approx 750 ISTS Nodes.
- SDH based network – Capacity STM-1 / 4/ 16.
- As per CERC Tariff Regulation, life of SDH equipment is 15 Yrs.

Present Power System Applications

- i. SCADA
- ii. PMU
- iii. Tele protection
- iv. Telecontrol
- v. AGC
- vi. Voice
- vii. Automated Metering Application
- viii. Video conferencing
- ix. ICCP (between control centers)
- x. Station to PDC
- xi. PDC to PDC
- xii. Supervision of communications System
- xiii. Video Surveillance
- xiv. Data Sync between MCC & BCC

Options of Migration to MPLS:

- New Nodes / replacement of SDH nodes completing its useful life to be provided with suitable MPLS equipment at the node, intervening path and respective RLDC.
- Integration of MPLS equipment with the existing SDH system at nodes and respective RLDC .
- 2 technologies are available MPLS TP / IP.

Challenges in Migration to MPLS:

- Adopting MPLS TP / IP / Hybrid wrt ISTS System functional requirements esp. latency.
- Dovetailing of MPLS-TP/IP with legacy SDH network at full existing capacity.
- Seamless integration of MPLS with its various technologies viz TP / IP/ Hybrid.
- Optimization of existing repeaters (Locations) for the MPLS Network. MPLS network may require more repeaters as compared to legacy SDH network and may not be able to support single hop of upto 200-225 km.
- Latency of MPLS network needs to be designed for meeting the voice & data communication as per CEA Technical Standards 2020.
- MPLS may not support as many directions as supported in SDH network.
- Compatibility of different MPLS networks for providing centralized supervision.

Adoption of New Technologies

Regulation

As per clause 22 of CEA (Technical Standards for Communication System in Power System Operations) Regulations 2020

Adoption of new technologies. Plan shall be made for introduction and adoption of new technologies, with the approval of the appropriate Commission or as per the regulations or pursuant to the reforms programme of the appropriate Government.

Thank You

ANNEXURE A17

ANNEXURE I

Sl. No.	Region	Utility	Substation	Nos. of meters	Fiber Optic Communication available at substation (Yes-Dual Path; Yes-Single Path/ NA)	Remarks, if any	Automatic Meter Reading (AMR) Data Available (Yes/ No)	AMR Communication through Fiber Optic/ GPRS/ NA
1	North East	NEEPCO	RC Nagar	18	Yes, Dual Path	--	No	NA
2	North East	NEEPCO	AGBPP	21	Yes, Single Path	--	No	NA
3	North East	NEEPCO	Doyang	12	Yes, Dual Path	--	No	NA
4	North East	NEEPCO	Kameng	13	NA	Single path via Balipara is in progress. Second path via Khupi-Tenga-Balipara is under progress.	No	NA
5	North East	NEEPCO	Khandong	18	NA	Path cannot be determined as plant is under renovation after flooding incident	No	NA
6	North East	NEEPCO	Kopili	15	NA	Path cannot be determined as plant is under renovation after flooding incident	No	NA
7	North East	NEEPCO	Kopili-2	4	NA	Path cannot be determined as plant is under renovation after flooding incident	No	NA
8	North East	NEEPCO	Pare	11	Yes, Dual Path	--	No	NA
9	North East	NEEPCO	Ranganadi	21	Yes, Dual Path	--	No	NA
10	North East	NTPC	BgTPP	21	Yes, Single Path	--	No	NA
11	North East	NHPC	Loktak	12	Yes, Dual Path	--	No	NA
12	North East	OTPC	Palatana	17	Yes, Single Path	Second path via Silchar is under progress.	No	NA
13	North East	Arunachal Pradesh	Lekhi	2	Yes, Single Path	--	No	NA
14	North East	Arunachal Pradesh	Deomali	1	NA	Single path via Kathalguri is in progress.	No	NA
15	North East	Arunachal Pradesh	Chimpu	4	Yes, Dual Path	--	No	NA
16	North East	Arunachal Pradesh	Tenga	2	NA	--	No	NA
17	North East	Assam	Agia	2	Yes, Dual Path	--	No	NA
18	North East	Assam	Azara	2	Yes, Dual Path	--	No	NA
19	North East	Assam	Umrangshu	2	NA	--	No	NA
20	North East	Assam	Pavoi	2	NA	--	No	NA
21	North East	Assam	BTPS	4	Yes, Single Path	--	No	NA
22	North East	Assam	Karimganj	2	NA	Single path via Badarpur/Kumarghat is in progress.	No	NA
23	North East	Assam	Haflong	1	NA	--	No	NA
24	North East	Assam	Mariani	2	Yes, Dual Path	--	No	NA
25	North East	Assam	Kahilipara	2	Yes, Single Path	--	No	NA
26	North East	Assam	Panchgram	2	Yes, Single Path	--	No	NA
27	North East	Assam	Dullavcherra	1	NA	--	No	NA
28	North East	Assam	Sarusajai	2	Yes, Dual Path	--	No	NA
29	North East	Assam	Pailapool	1	Yes, Dual Path	--	No	NA
30	North East	Assam	Bokajan	1	NA	--	No	NA
31	North East	Assam	Gohpur	3	Yes, Single Path	--	No	NA
32	North East	Assam	Samaguri	2	Yes, Dual Path	--	No	NA
33	North East	Assam	Tinsukia	2	Yes, Single Path	--	No	NA
34	North East	Assam	Srikona	2	Yes, Dual Path	--	No	NA
35	North East	Assam	Sonabil	1	Yes, Dual Path	--	No	NA
36	North East	Assam	Hailakandi	2	NA	--	No	NA
37	North East	Assam	Golaghat	1	NA	--	No	NA
38	North East	Assam	Rangia	1	Yes, Dual Path	--	No	NA
39	North East	Manipur	Yurembam	4	Yes, Single Path	--	No	NA
40	North East	Manipur	Ningthoukhong	2	Yes, Dual Path	--	No	NA
41	North East	Manipur	Karong	1	NA	--	No	NA
42	North East	Manipur	Jiribam	2	Yes, Single Path	--	No	NA
43	North East	Manipur	Thoubal	2	Yes, Dual Path	--	No	NA
44	North East	Manipur	Rengpang	1	Yes, Single Path	--	No	NA
45	North East	Manipur	Tipaimukh	2	NA	--	No	NA
46	North East	Meghalaya	Umtru	4	Yes, Single Path	--	No	NA
47	North East	Meghalaya	Khleiriat	2	Yes, Single Path	--	No	NA
48	North East	Meghalaya	Mendipathar	1	Yes, Single Path	--	No	NA
49	North East	Meghalaya	Nangalibra	1	Yes, Single Path	--	No	NA
50	North East	Meghalaya	Lumshnong	1	Yes, Single Path	--	No	NA
51	North East	Meghalaya	Byrnihat	4	NA	--	No	NA
52	North East	Mizoram	Kolasib	2	Yes, Dual Path	--	No	NA
53	North East	Mizoram	Shimmui	2	Yes, Single Path	--	No	NA
54	North East	Mizoram	Lungmual	1	Yes, Single Path	--	No	NA
55	North East	Mizoram	Zuangtui	1	Yes, Single Path	--	No	NA
56	North East	Nagaland	Kohima	2	Yes, Single Path	--	No	NA
57	North East	Nagaland	Dimapur	2	Yes, Single Path	--	No	NA

2 nos. of meters added

1 no. of meter removed

1 no. of meter removed

2 nos. of meters added.

New entry

58	North East	Nagaland	Mokokchung	3	Yes, Dual Path	--	No	NA	
59	North East	Nagaland	Sanis	1	Yes, Single Path	--	No	NA	
60	North East	Tripura	Agartala	2	Yes, Single Path	--	No	NA	
61	North East	Tripura	P.K. Bari	4	Yes, Single Path	--	No	NA	
62	North East	Tripura	S.M. Nagar	4	Yes, Single Path	--	No	NA	
63	North East	Tripura	Dharmanagar	1	NA	--	No	NA	
64	North East	Tripura	Udaipur	1	Yes, Single Path	--	No	NA	
65	North East	Tripura	Ambassa	1	NA	--	No	NA	
66	North East	Tripura	Budhjungnagar	1	Yes, Single Path	--	No	NA	
67	North East	POWERGRID	Badarpur	7	Yes, Dual Path	--	No	NA	
68	North East	POWERGRID	Balipara	22	Yes, Dual Path	--	No	NA	1 no. of meter added.
69	North East	POWERGRID	BNC	20	Yes, Single Path	Second path via Rangia-Bongiangoan is under progress.	No	NA	
70	North East	POWERGRID	Bongaigaon	18	Yes, Dual Path	--	No	NA	
71	North East	POWERGRID	Dimapur	15	Yes, Dual Path	--	No	NA	2 nos. of meters added.
72	North East	POWERGRID	Haflong	3	Yes, Single Path	--	No	NA	
73	North East	POWERGRID	Imphal	21	Yes, Dual Path	--	No	NA	1 no. of meter added.
74	North East	POWERGRID	Jiribam	6	Yes, Dual Path	--	No	NA	
75	North East	POWERGRID	Khleiriat	5	Yes, Dual Path	--	No	NA	
76	North East	POWERGRID	Kumarghat	4	Yes, Dual Path	--	No	NA	
77	North East	POWERGRID	Mariani	14	Yes, Dual Path	--	No	NA	2 nos. of meters added.
78	North East	POWERGRID	Melriat	6	Yes, Dual Path	--	No	NA	
79	North East	POWERGRID	Misa	21	Yes, Dual Path	--	No	NA	1 no. of meter added.
80	North East	POWERGRID	Mokokchung	11	Yes, Dual Path	--	No	NA	3 nos. of meters added.
81	North East	POWERGRID	Nirjuli	6	Yes, Dual Path	--	No	NA	
82	North East	POWERGRID	Namsai	3	NA	VSAT Available	No	NA	
83	North East	POWERGRID	Roing	2	NA	VSAT Available	No	NA	
84	North East	POWERGRID	Salakati	7	Yes, Dual Path	--	No	NA	
85	North East	POWERGRID	Silchar	24	Yes, Dual Path	--	No	NA	3 nos. of meters added.
86	North East	POWERGRID	Aizawl	5	Yes, Dual Path	--	No	NA	
87	North East	POWERGRID	Ziro	1	Yes, Single Path	--	No	NA	
88	North East	INDIGRID	P.K. Bari	11	Yes, Single Path	--	No	NA	
89	North East	INDIGRID	S.M. Nagar	10	Yes, Single Path	--	No	NA	1 nos. of meter removed.
90	North East	KMTL	New Kohima	8	Yes, Dual Path	--	No	NA	

Power System Operation Corporation Ltd.
National Load Despatch Center (NLDC), New Delhi

दिनांक: 07 October 2022

सेवा में,
All the Stakeholders

विषय: Extension of date for Public stakeholder consultation on the draft detailed procedure on the operational aspects of Secondary Reserve Ancillary Services (SRAS)

संदर्भ: Central Electricity Regulatory Commission (CERC) (Ancillary Services) Regulations, 2022

महोदय/महोदया,

CERC (Ancillary Services) Regulations, 2022 have been notified on 31st January, 2022 which would come into force from a date to be notified subsequently by the Hon'ble Commission.

As per the above regulations, NLDC has been designated as the Nodal Agency. As per the extant regulatory provisions, a draft detailed procedure on the operational aspects of SRAS has been formulated by the Nodal Agency, and has been floated for stakeholder consultations on 23rd September, 2022.

The draft detailed procedure on the operational aspects of SRAS is enclosed herewith for public stakeholder inputs/suggestions. The aforesaid draft detailed procedure is also placed on the POSOCO website at <https://posoco.in/documents/consultation-papers/>

Suggestions/feedback on this draft detailed procedure on the operational aspects of SRAS may kindly be forwarded to ancillary@posoco.in. The last date of submission of stakeholder comments is, hereby, extended from 07th October, 2022 to **16th October, 2022.**

सधन्यवाद,

भवदीय,
देवाशिस दे
(देवाशिस दे)
कार्यकारी निदेशक
07/10/22

संलग्न – Draft Detailed Procedure on the Operational Aspects of SRAS

प्रतिलिपि – Secretary, CERC



Power System Operation Corporation Ltd.
Nodal Agency - National Load Despatch Centre (NLDC)

Detailed Procedure
on
Operational Aspects
for
Secondary Reserve Ancillary Services (SRAS)

*Prepared in Compliance to
Central Electricity Regulatory Commission (Ancillary Services)
Regulations, 2022*

September 2022



Table of Contents

1.0	Preamble	4
2.0	Objective	5
3.0	Definitions.....	5
4.0	Roles	5
4.1	Nodal Agency	5
4.2	Regional Load Despatch Centres (RLDCs)	6
4.3	State Load Despatch Centres (SLDCs).....	7
4.4	Regional Power Committees (RPCs)	7
4.5	SRAS Providers	7
4.6	Communication Providers	8
5.0	Eligibility of SRAS Provider	8
6.0	Bi-directional Communication System	9
7.0	SCADA Telemetry and Metering.....	10
8.0	Computation of Area Control Error.....	11
9.0	Procurement of SRAS	11
10.0	Activation and Deployment of SRAS	12
11.0	Selection of SRAS Providers and Despatch of SRAS	13
12.0	Performance Assessment and Incentive Calculation.....	14
13.0	Failure in performance of SRAS Provider	16
14.0	Cyber Security.....	17
15.0	Shortfall in Procurement of SRAS	17
16.0	SRAS Despatch in case of Emergency Conditions.....	18
17.0	Energy Accounting of SRAS	18
18.0	Settlement of SRAS.....	19
19.0	Revision of the procedures	21
	Annexure – I: Technical and Commercial Parameters of SRAS Providers	22
	Annexure-II: SOP for AGC Communication Providers.....	24
	Annexure-III: Open Loop and Closed Loop Testing Procedures	25
	Annexure-IV: Suggested Generic Hardware Specifications for AGC Connecting Equipment.....	28



Annexure-V: Detailed Signal Lists	30
Annexure-VI: Guideline for Calculation and Monitoring of Area Control Error (ACE) ...	44
Annexure -VII: Standard Operation Guidelines for Power Plants under AGC.....	54
Annexure -VIII: Guidelines for operating intra-state generators/entities under AGC from NLDC	69
Annexure -IX: Detailed Methodology for Performance Assessment and Data Filtering	71
Annexure -X: Undertaking on Cyber Security	74
Format-SRAS1: SRAS Settlement Account by RPC	75
Format-SRAS2: SRAS Settlement Account by RPC	76
Format SRAS-3: Standing Consent by SLDC to Intra-State SRAS Provider.....	77

Draft



1.0 Preamble

- 1.1 Maintaining frequency stability is critical for the integrated operation of a large interconnected power system like India. Generally, frequency response of any power system can be characterized by different time window-based responses, such as, inertial, primary frequency, secondary frequency, and tertiary frequency response.
- 1.2 Secondary response is a reliability service and acts as a replacement to the exhausted primary frequency reserves and hence helps in maintaining frequency stability and reliability.
- 1.3 Secondary frequency control has been operationalized in the Indian power system through Automatic Generation Control (AGC) pan-India since 20th July 2021. A total of 66 power plants with an installed capacity of around 64000 MW have been continuously operating 24x7.
- 1.4 Central Electricity Regulatory Commission (CERC) has notified (Ancillary Services) Regulations, 2022, hereinafter referred to as the "AS Regulations". It has provided for Ancillary Services in the form of Secondary Reserve Ancillary Services (SRAS) and Tertiary Reserve Ancillary Services (TRAS). As per the regulations, NLDC has been designated as the Nodal Agency. Further, it has been provided that detailed procedure on the operational aspects of Secondary Reserve Ancillary Services (SRAS) are to be submitted by the Nodal Agency (Regulation 23(1)) for the information of the Hon'ble Commission.
- 1.5 SRAS means the Ancillary Service comprising SRAS-Up and SRAS-Down, which is activated and deployed through secondary frequency control signal.
- 1.6 National Load Despatch Centre i.e. the Nodal Agency, in coordination with RLDCs and SLDCs, would estimate the quantum of requirement of SRAS at the regional level after factoring in the reserves for each state control area, for such period and based on such methodology as specified in the Grid Code and publish the same on its website. Nodal Agency has proposed an interim methodology for estimation of reserves for approval of the Central Commission post stakeholder consultations.
- 1.7 This procedure provides the operational aspects of procurement, deployment and payment of SRAS in accordance with the CERC (Ancillary Services) Regulations, 2022.



2.0 Objective

- 2.1 The objective of this procedure is to lay down the roles and methodology to be followed for the operational aspects of procurement, deployment and payment of SRAS to be followed by the Nodal Agency (NLDC), RLDCs, SLDCs, RPCs, CTUIL, Communication Providers, and SRAS Providers.

3.0 Definitions

- 3.1 **'Communication Providers'** would provide end to end redundant communication system between SRAS Provider and Nodal Agency. CTUIL shall be the communication provider between Nodal Agency and SRAS Provider.
- 3.2 All the words and expressions used in the Procedure shall have the same definition as assigned to them in various CERC Regulations.

4.0 Roles

4.1 Nodal Agency

- 4.1.1 Nodal Agency would generate the automated AGC signal (SRAS Up or SRAS Down) which would be followed by the SRAS Provider to adjust the generation to maintain or restore grid frequency within the allowable band as specified in the Grid Code or replenish primary reserves.
- 4.1.2 Nodal Agency would, in coordination with RLDCs and SLDCs, estimate the quantum of requirement of SRAS on day-ahead basis and re-assess incremental requirement, if any, on real time basis based on methodology notified on the NLDC website.
- 4.1.3 Nodal Agency would specify the requirements of the bi-directional communication system between SRAS Provider and NLDC/RLDCs.
- 4.1.4 Nodal Agency would detail the metering and SCADA telemetry to be in place for monitoring and measurement of energy delivered under SRAS by the SRAS Providers.
- 4.1.5 Nodal agency would auto-calculate Area Control Error (ACE) for each region. Frequency Bias Coefficient (Bf) shall be assessed and declared by the Nodal Agency. Offset shall be used to account for measurement errors and shall be decided by the Nodal Agency for the respective region.



- 4.1.6 Nodal Agency would specify the technical and commercial parameters to be submitted by the SRAS Providers.
- 4.1.7 Nodal Agency would select the SRAS Provider for provision of SRAS-Up/Down based on the Custom Participation Factor, which would be determined for each SRAS provider.
- 4.1.8 Nodal Agency would provide the methodology for the computation for payment for SRAS and incentive based on performance.
- 4.1.9 The actual response of SRAS Provider against the secondary control signals from the Nodal Agency to the control centre of the SRAS Provider would be monitored by the Nodal Agency.
- 4.1.10 Nodal Agency would provide data to respective RPCs, through RLDCs, for the accounting and settlement through Regional Deviation and Ancillary Service Pool Account in respect of the SRAS providers on a weekly basis.
- 4.1.11 The Nodal Agency would publish information on its website about SRAS procured, scheduled and dispatched on weekly basis and submit monthly detailed feedback reports to the Central Commission.
- 4.1.12 In the case of intra-state generators participating in SRAS, Nodal Agency shall share the real time AGC MW quantum to the respective RLDC through ICCP.
- 4.1.13 In the case of intra-state generators participating in SRAS, Nodal Agency shall share the weekly SRAS 5-minute MWh and 15-minute MWh ex-bus quantum to the respective RLDC for onward transmission to the respective SLDCs.

4.2 Regional Load Despatch Centres (RLDCs)

- 4.2.1 The respective RLDCs would maintain the relevant scheduling data of inter-state entities during the SRAS operation (including but not limited to generating station-wise installed capacity, declared capacity, schedule, Un-Requisitioned Surplus (URS), generator wise SRAS schedules for up/down and requisitions from the generating stations). RLDCs shall verify the SRAS quantum data received from Nodal Agency. The implemented schedule data would be prepared by the RLDCs after including SRAS quantum.



4.2.2 In the case of intra-state generators participating in SRAS, RLDC shall forward the real time AGC MW quantum to the respective SLDC through ICCP.

4.2.3 In the case of intra-state generators participating in SRAS, RLDC shall forward the weekly SRAS 5-minute MWh and 15-minute MWh ex-bus quantum to the respective SLDC.

4.3 State Load Despatch Centres (SLDCs)

4.3.1 The respective SLDCs would maintain the relevant scheduling data of intra-state entities during the SRAS operation (including but not limited to generating station-wise installed capacity, declared capacity, schedule, Un-Requisitioned Surplus (URS), generator wise SRAS schedules for up/down and requisitions from the generating stations).

4.3.2 SLDCs shall use the real time AGC MW data obtained through ICCP from the RLDCs, and incorporate it to the state's net schedule for the purpose of monitoring deviations.

4.3.3 AGC DeltaP quantum for intra-state generators shall be incorporated in state's net schedule (with appropriate sign) for the purpose of computation of deviations by SLDC or appropriate agency in the state. Hence, generation of the intra-state generator under AGC would not be considered as deviation of the state.

4.3.4 SLDCs shall use the 15-minute SRAS MWh quantum data received from RLDC for deviation settlement.

4.4 Regional Power Committees (RPCs)

4.4.1 The respective RPCs shall prepare weekly SRAS accounts based on the data provided to them by the Nodal Agency/RLDCs.

4.4.2 For the intra-state generators, the settlement of payments towards SRAS-Up/SRAS-Down 15-minute MWh along with the performance based incentive would be done by the RPC with the respective Regional Deviation and Ancillary Service Pool Account.

4.5 SRAS Providers

4.5.1 SRAS Providers would provide the technical and commercial parameters to the Nodal Agency as per **Annexure – I**.



- 4.5.2 SRAS Provider would adjust the generation as per the automated AGC signal (SRAS Up or SRAS Down) by Nodal Agency.
- 4.5.3 SRAS Providers other than section-62 plants, shall provide the bank account details for settlement of AGC incentives/mileage (as per format **SRAS-3**).

4.6 Communication Providers

- 4.6.1 Communication Providers would provide end to end redundant communication system between SRAS Provider and Nodal Agency in accordance with CERC (Communication System for inter-State transmission of electricity) Regulations, 2017.
- 4.6.2 Communication Providers shall provide two different paths for maintaining redundancy of the communication path ensuring route diversity and dual communication.
- 4.6.3 In case of multiple Communication Providers involving CTUIL and STU, both the Communication Providers shall coordinate to arrange communication between SRAS Provider and Nodal Agency.
- 4.6.4 Communication Providers shall have Network Management System for monitoring and troubleshooting communication links on a 24x7 basis in line with CERC (Communication System for inter-state transmission of electricity) Regulations, 2017.
- 4.6.5 Assessment and maintenance of communication system has to be done by Communication Providers in real-time to maintain the availability of communication system.
- 4.6.6 Communication Providers shall coordinate with their infrastructure providers/maintenance providers/vendors/OEMs to provide end to end communication between SRAS provider and Nodal Agency with round-the-clock support and prompt response as per Standard Operating Procedure issued by Nodal Agency (**Annexure-II**).
- 4.6.7 Four (two for primary control centre-PCC and two for back up control centre-BCC) ethernet ports shall be provided by the Communication Provider at the nearest available wide band node to the SRAS Provider.

5.0 Eligibility of SRAS Provider



- 5.1 A generating station or an entity having energy storage resource, on standalone or aggregated basis, connected to inter-State transmission system or intra-State transmission system, shall be eligible to provide Secondary Reserve Ancillary Service, as an SRAS Provider, if it:
 - 5.1.1 has bi-directional communication system with NLDC/RLDC;
 - 5.1.2 is AGC-enabled, in case of a generating station;
 - 5.1.3 can provide minimum response of 1 MW;
 - 5.1.4 has metering and SCADA telemetry in place for monitoring and measurement of energy delivered under SRAS
 - 5.1.5 is capable of responding to SRAS signal within 30 seconds and providing the entire SRAS capacity obligation within fifteen (15) minutes and sustaining at least for the next thirty (30) minutes;
- 5.2 Intra-state generators shall inform and take consent from the respective SLDC (as per format SRAS-3) to become an SRAS Provider.
- 5.3 SRAS Provider shall complete the Open Loop and Closed Loop tests conducted by the Nodal Agency as per **Annexure-III**.

6.0 Bi-directional Communication System

- 6.1 IEC-60870-5-104 protocol is to be used for setting up bi-directional communication between SRAS provider and Nodal Agency using communication system provided by Communication Provider.
- 6.2 SRAS provider shall arrange a dedicated Remote Terminal Equipment (RTU) for AGC, Routers, Switches and any converters (like optical to ethernet) for setting up communication using IEC-60870-5-104 protocol.
- 6.3 The minimum generic hardware specifications for bi-directional communication system are provided in **Annexure-IV**. Depending on the number of units and available infrastructure, SRAS Provider needs to plan, customize and procure its hardware including spares for facilitating bi-directional communication system.
- 6.4 RTU is needed to be synchronized with GPS clock signal or it has to be synced with Nodal Agency servers via clock sync protocol scan.



- 6.5 SRAS Provider is accountable for RTU maintenance and troubleshooting for participation in SRAS. The RTU shall be capable of handling arithmetic and logical functions, archival of data and creating reports.

7.0 SCADA Telemetry and Metering

7.1 SCADA Telemetry

- 7.1.1 Telemetry provided via IEC-104 needs to be configured as various types of points-
- 7.1.1.1 Single Point Digital Status: This is a single point digital status which may be configured and sent by SRAS provider to Nodal Agency as per the requirement.
 - 7.1.1.2 Dual Point Digital Status: This is a dual point digital status (Circuit Breaker Status of Units is used to configure as dual point digital status) which may be configured and sent by SRAS provider to Nodal Agency as per the requirement.
 - 7.1.1.3 Double Point Digital Command: This is a dual point command which may be configured and received by SRAS provider from Nodal Agency as per the requirement.
 - 7.1.1.4 Input Analog Point: This is an analog point which may be configured and sent by SRAS provider to Nodal Agency as per the requirement.
 - 7.1.1.5 Set point from Nodal Agency: This is an analog point which may be configured and received by SRAS provider from Nodal Agency as per the requirement. This point would be used for sending SRAS despatch instructions from Nodal Agency.
- 7.1.2 The detailed signal list used for Automatic Generation Control (AGC) along with logics to be implemented by the SRAS Provider in the RTU/Digital Control System (DCS) is attached as **Annexure-V**.

7.2 Measurement and Metering

- 7.2.1 All measurements of secondary control signals from the Nodal Agency to the control centre of the SRAS Provider and actual response of SRAS Provider shall be carried out at gross level on post-facto basis using SCADA data.

8.0 Computation of Area Control Error

8.1 The Area Control Error (ACE) for each region would be auto-calculated at the control centre of the Nodal Agency based on telemetered values and the external inputs, as per the following formula:

$$ACE = (I_a - I_s) - 10 * B_f * (F_a - F_s) + \text{Offset}$$

Where,

I_a = Actual net interchange in MW (positive value for export)

I_s = Scheduled net interchange in MW (positive value for export)

B_f = Frequency Bias Coefficient in MW/0.1 Hz (negative value)

F_a = Actual system frequency in Hz

F_s = Schedule system frequency in Hz

Offset = Provision for compensating for measurement error

8.2 The detailed methodology to be followed by Nodal Agency for calculation and monitoring of Area Control Error (ACE) is attached at **Annexure – VI.**

8.3 Nodal Agency may operate SRAS in any of the three control modes namely, tie-line bias control mode, flat frequency control mode or flat tie-line control mode depending on grid requirements. The AGC operation modes shall be archived for post-despatch purposes by the Nodal Agency.

9.0 Procurement of SRAS

9.1 SRAS shall be procured on regional basis by the Nodal Agency through the regulated mechanism as specified in the CERC (Ancillary Services) Regulation, 2022.

9.2 An SRAS Provider willing to participate in SRAS shall be required to provide standing consent to the Nodal Agency for participation in the next month 'M' by 8th day of the current month i.e. 'M-1' (if 8th day is holiday, then next working day), which shall remain valid till it is modified or withdrawn. The standing consent, except in case of forced outage, cannot be modified or withdrawn without giving notice of at least forty-eight (48) hours.

9.3 The SRAS Providers shall inform changes, if any, in the technical and commercial parameters of Annexure – I on monthly basis. In the case of absence of any update, the last available revision shall be considered by the Nodal Agency.



- 9.4 The SRAS Providers that are generating stations whose tariff is determined under section 62 of the Act, would declare their energy charges upfront on monthly basis.
- 9.5 The SRAS Providers, other than those covered under section 62 of the Act, shall be required to declare the compensation charges upfront on monthly basis.
- 9.6 There shall not be any commitment charge for the SRAS providers.

10.0 Activation and Deployment of SRAS

- 10.1 SRAS shall be activated and deployed by the Nodal Agency on account of the following events to maintain or restore grid frequency within the allowable band as specified in the Grid Code or replenish primary reserves:
- 10.1.1 Considering a region as control area, Area Control Error (ACE) of the region, going beyond the minimum threshold limit of ± 10 MW.
- 10.1.2 Such other events as specified in the Grid Code/CERC regulations on Ancillary Services.
- 10.2 SRAS shall be despatched on regional basis through secondary control signals by the Nodal Agency.
- 10.3 Secondary control signal for SRAS-Up and SRAS-Down shall be sent to the SRAS Provider every 4 seconds by the Nodal agency.
- 10.4 SRAS Provider shall allow its control centre to follow the secondary control signal for SRAS-Up or SRAS-Down automatically without manual intervention.
- 10.5 The SRAS Provider shall increase or decrease active power injection or increase or decrease drawal or consumption, as the case may be, as per the automatic signal from the Nodal Agency.
- 10.6 All the signals as mentioned in the detailed signal list at **Annexure-V** shall be shared by the SRAS Provider through IEC 104 protocol directly with the



Nodal Agency. Nodal Agency shall share the same with the respective RLDC through ICCP.

- 10.7 The SRAS Provider shall share real-time data with NLDC and the concerned RLDCs as per the Standard Operating Guidelines for the SRAS Providers (**Annexure-VII**). These guidelines would be revised time to time, based on experience and with the introduction of new technologies.
- 10.8 For monitoring of AGC, SRAS provider, Communication Provider and Nodal Agency shall maintain suitable SCADA/IT dashboards.
- 10.9 The activation and deployment of SRAS for intra-state generators can be done by NLDC, as per the guidelines mentioned in Section-9 of this procedure and **Annexure-VIII**. The intra-state generators under SRAS would be dispatched to control regional ACE.

11.0 Selection of SRAS Providers and Despatch of SRAS

- 11.1 SRAS Provider shall be selected, on regional basis, by the Nodal Agency for providing SRAS-Up or SRAS-Down based on the Custom Participation Factor.
- 11.2 AGC uses smooth ACE which is the output of the PID controller and uses raw ACE as input. Smooth ACE signal shall be allocated among the SRAS Providers to meet SRAS requirement of the system based on the normalised Custom Participation Factor subject to the ramp limited resources available with the SRAS Provider(s).
- 11.3 Custom Participation Factor shall be computed for deciding the distribution of the Smoothed Area Control Error between the power plants in a control area.
- 11.4 Custom Participation Factor shall be calculated based on the normalized values of the declared Ramp Rate and Energy Charge (Section 62 plants) or Compensation Charge (Other than Section 62 plants).
- 11.5 The Custom Participation Factor for each SRAS Provider shall be determined by the Nodal Agency based on the following criteria:
 - 11.5.1 Rate Participation Factor (Ramping capability in MW/min); and
 - 11.5.2 Cost Factor (energy charge or compensation charge, as the case may be).

- 11.6 The Custom Participation Factor for SRAS-Up shall be directly proportional to the normalised Rate Participation Factor and inversely proportional to the normalised Cost Factor.
- 11.7 The Custom Participation Factor for SRAS-Down shall be directly proportional to the product of the normalised Rate Participation Factor and normalised Cost Factor.
- 11.8 Based on the above principles, Custom Participation Factor shall be calculated which shall be normalised to determine the participation of each SRAS Provider.
- 11.9 SRAS signal shall be allocated among the SRAS Providers on regional basis to meet the SRAS requirement of the system based on the normalised Custom Participation Factor subject to the ramp limited resources available with the SRAS Provider(s).
- 11.10 A sample illustration with five (5) SRAS Providers (A, B, C, D and E) for calculation of Custom Participation Factor has been shown in Table-1 for Up regulation.

Plant name	Declared Capacity Pmax (MW)	Schedule (MW)	UP Reserve (MW)	Rate Factor (MW/min)	Cost Factor (paise/kWh)	Normalized Rate Participation Factor	Normalized Cost Factor	Custom Participation Factor (CPF)	Normalised Custom Participation Factor (NCPF)	SRAS-Up Requirement (MW) (assumed)	SRAS-UP Capacity with NCPF	SRAS Desired Signal	4-second ramp rate(MW/min)	SRAS Control signal for the next 4 seconds	SRAS Control signal after 8 seconds	Time to achieve Desired SRAS [@] at "m" (minutes)
	(a)	(b)	(c)=(a)-(b)	(d)	(e)	(f) = [(d)/sum(d)]	(g) = [(e)/sum(e)]	(h) = [(f)/(g)]	(i) = [(h)/sum(h)]	(k)	(j) = (i)x(k)	(m) = (l) subject to (c)	(n)=(d)*4/60	(o)=(n)	(p)= (o)+/-(n)	(q)=(m)/(d)
A	4150	4000	150	41.5	194	0.16	0.15	1.0	0.19	340	66	65.8	2.8	2.8	5.5	1.58
B	400	250	150	100	231	0.38	0.18	2.1	0.39		133	149*	6.7	6.7	13.3	1.49
C	1050	950	100	10.5	264	0.04	0.21	0.2	0.04		12	12.2	0.7	0.7	1.4	1.62
D	1000	900	100	100	265	0.38	0.21	1.8	0.34		116	100 [#]	6.7	6.7	13.3	1.00
E	1320	1200	120	13.2	314	0.05	0.25	0.2	0.04		13	12.9	0.9	0.9	1.8	0.98
Note:																
(i) "#" SRAS desired signal of 16 MW clipped from SRAS Provider D, considering the SRAS-Up reserves available with SRAS Provider D.																
(ii) "*"SRAS desired signal of 16 MW clipped from SRAS Provider D is allocated to the SRAS Provider with the highest normalised Custom Participation Factor first and so on - in this case, it is allocated to SRAS Provider B.																
(iii) "\$" AGC shall follow desired signal with ramp rate (n) if ACE (k) is in the same direction (+); (-) means oppsite direction like -340																
(iv)"\$"ACE (column k) can change direction frequently and so does (m); However, (p) changes only based on previous (o)+/-(4 second ramp rate)																
(v)@ Assuming that ACE is the same direction for those many minutes																

12.0 Performance Assessment and Incentive Calculation

- 12.1 Average of SRAS-Up and SRAS-Down MW data shall be calculated by the Nodal Agency for every 5 minutes in absolute terms using archived SCADA data at the Nodal Agency. This data would be reconciled with the data



received from the SRAS Provider at the Nodal Agency and shall be used for performance assessment as well as incentive calculation.

- 12.2 All measurements of secondary control signals from the Nodal Agency to the control centre of the SRAS Provider and actual response of SRAS Provider shall be carried out on post-facto basis using SCADA data.
- 12.3 The actual response of SRAS Provider against the secondary control signals from the Nodal Agency to the control centre of the SRAS Provider shall be monitored by the Nodal Agency.
- 12.4 Performance of the SRAS Provider shall be measured by the Nodal Agency by comparing the actual response against the secondary control signals for SRAS-Up and SRAS-Down sent every 4 seconds to the control centre of the SRAS Provider measured using 5-minute average data.
- 12.5 When the power plant is in Remote, the Actual MW should follow AGC Set Point. Performance metric is measured by plotting the Output versus Input. All the below values are available at gross level (ex-power plant) obtained through IEC-104 protocol from the dedicated RTU. Five minutes average MW data for the periods when the units are on bar and in Remote may be used for calculations. Consider CB and Remote status signals in calculations. Map CB ON as 1 (Note that as CB is a double point signal, its ON value will be 2. Map the same to 1). Similarly, Map CB OFF as 0. Local Remote status (LR) is a single point signal. Map Local as 0 and Remote as 1. For 'n' units,
- $Output = \sum_{i=1}^n ((Actual\ MW_n - ULSP_n - RGMO_n) * CB_n * LR_n)$
 - $Input = \sum_{i=1}^n ((DeltaP_n) * CB_n * LR_n)$
 - Plot a scatter plot of Output vs Input.
 - 288x7 data points per plant for one week would appear on the scatter plot.
 - Add a Trend Line ($Y=mX$) to the plot with Intercept=0. Display equation on chart.
 - Check the value of 'm' in $Y=mX$. Ideal performance would be $Y=X$.
 - Say the equation is $Y=0.8X$, then consider the performance is 80%.
 - If the RGMO MW input to the governor data is not telemetered / provided, consider the value as zero.
- 12.6 The Output MW data is derived from Actual MW, ULSP and RGMO MW, which are all telemetered SCADA signals and may contain some noise. The method mentioned in **Annexure-IX** would be used for filtering the Gross Output MW data while calculating the performance of the power plants under AGC. As a result, there would be minimal or no manual intervention while carrying out these calculations.



- 12.7 SRAS Provider shall be eligible for incentive based on the performance measured and the 5-minute MWh data calculated for SRAS-Up and SRAS-Down aggregated over a day, as under:

Actual performance vis-à-vis secondary control signal for an SRAS Provider	Incentive Rate (paise/kWh)
95 % and above	(+) 50
75 % to below 95%	(+) 40
60 % to below 75%	(+) 30
50% to below 60%	(+) 20
20 % to below 50%	(+) 10
Below 20%	0

- 12.7.1 Incentive payments shall be calculated for each SRAS Provider, being a generating station, for energy supplied for a day as follows:

$$\text{Incentive for SRAS Provider} = \text{Actual Response (MWh)} \times (1 - \text{NAC}) \times \text{Incentive Rate}$$

- 12.7.2 for each SRAS Provider being an entity other than a generating station, for energy supplied for a day as follows:

$$\text{Incentive for SRAS Provider} = \text{Actual Response (MWh)} \times \text{Incentive Rate}$$

Where,

'Actual Response' is the actual energy output (in MWh) of the SRAS Provider communicated to the Nodal Agency aggregated over 5 minutes in absolute terms and then summed for a day.

'NAC' is percentage Normative Auxiliary Energy Consumption for similar class of generating stations, as specified in the Tariff Regulations.

'Incentive Rate' in Paise/kWh is the incentive rate applicable based on the performance assessment of SRAS Provider.

13.0 Failure in performance of SRAS Provider

- 13.1 Poor Performance Metric indicates an underlying problem such as restrictive/conservative limits imposed by the SRAS Provider on the AGC Signal, incorrectly tuned control systems, non-understanding the operating guidelines etc.



- 13.2 Performance below 20% for two consecutive days by an SRAS Provider shall make the SRAS Provider liable for disqualification for participation in SRAS for a week by the Nodal Agency. The details of such SRAS provider and the period of disqualification shall be provided by Nodal Agency through respective RLDCs (Format-SRAS2) to RPCs.
- 13.3 Respective RPCs shall publish the same (Format-SRAS2) along with (Format-SRAS1). If disqualified by the Nodal Agency, only after rectification of the issues and providing satisfactory explanation by email, SRAS Provider shall be eligible to participate in SRAS again.
- 13.4 Violation of directions of the Nodal Agency for SRAS under these Regulations shall make the SRAS Providers liable for penalties as per the provision of the Act.

14.0 Cyber Security

- 14.1 SRAS Providers shall take necessary cyber security measures for the purpose of grid security and plant safety. SRAS Providers shall ensure that no extra devices are connected to the AGC equipment and regular monitoring may be ensured. SRAS Providers shall submit the signed undertaking as per **Annexure-X** to the Nodal Agency.

15.0 Shortfall in Procurement of SRAS

- 15.1 All generating stations, whose tariff is determined by the Commission under Section 62 of the Act including those having Un-Requisitioned Surplus (URS) power after declaration of the Real Time Market (RTM) results, shall be deemed to be available for use by the Nodal Agency for SRAS, subject to technical constraints of such generating stations.
- 15.2 The generating stations as referred to above, whose URS is despatched as SRAS-Up shall be paid their energy charge and incentive.
- 15.3 The generating stations as referred to above, if despatched as SRAS-Down shall pay back to the Deviation and Ancillary Service Pool Account and shall be paid incentive.

16.0 SRAS Despatch in case of Emergency Conditions

- 16.1 In case the Nodal Agency requires any generating station to provide Ancillary Services to meet the emergency conditions for reasons of grid security as per the provisions of the Grid Code, such generating station shall be compensated at the rate of the energy charge as determined under Section 62 of the Act or adopted under Section 63 of the Act, or at the rate of the compensation charge declared by the AS provider, as the case may be.

17.0 Energy Accounting of SRAS

- 17.1 Deviation of AS Provider in every 15 minutes time block shall be calculated as under and settled as per the procedure of the DSM Regulations:
- 17.1.1 MWh Deviation for AS Provider = (Actual MWh of AS Provider) – (Scheduled MWh of AS Provider including TRAS MWh despatched) – (SRAS MWh of AS Provider despatched)
- 17.2 SRAS Provider shall archive the below signals for the purpose of accounting and send the data of the previous week to the Nodal Agency through email every Monday in the format provided by NLDC.
- 17.2.1 5-minute average MW and 5-minute MWh of the AGC input (DeltaP) provided to the power plant control system, which is added to the load set point. Note that DeltaP shall be calculated (non-zero) only when the unit is on bar and in Remote.
- 17.2.2 15-minute average MW and 15-minute MWh of the input (DeltaP) provided to the power plant control system, which is added to the load set point. Note that DeltaP shall be calculated (non-zero) only when the unit is on bar and in Remote.
- 17.3 Nodal Agency through respective RLDCs shall furnish 15-minute average MWh SCADA data of SRAS Provider to RPCs on weekly basis.
- 17.4 In the case of intra-state generators participating in SRAS, Nodal Agency shall share the weekly SRAS 5-minute MWh and 15-minute MWh ex-bus quantum to the respective RLDC for onward transmission to the respective SLDCs.



- 17.5 AGC DeltaP quantum for intra-state generators shall be incorporated in state's net schedule (with appropriate sign) for the purpose of computation of deviations by SLDC or appropriate agency in the state. Hence, generation of the intra-state generator under AGC would not be considered as deviation of the state. SLDCs shall use the 15-minute SRAS MWh quantum data received from RLDC for deviation settlement.
- 17.6 For the intra-state generators, the settlement of payments towards SRAS-Up/SRAS-Down 15-minute MWh along with the performance based incentive would be done by the RPC with the respective Regional Deviation and Ancillary Service Pool Account.
- 17.7 Accounts (as per Formats **SRAS-1** and **SRAS-2**) would be prepared by the concerned RPC.
- 17.8 No separate bills shall be raised for this purpose. No retrospective settlement of energy charge or compensation charge for SRAS, as the case may be, shall be undertaken.

18.0 Settlement of SRAS

- 18.1 The payment to SRAS Provider(s) shall be from the surplus available in Deviation and Ancillary Service Pool Account of the concerned Region where the SRAS Provider(s) is located.
- 18.2 The payments related to the SRAS shall be settled from the concerned RLDC's "Regional Deviation and Ancillary Service Pool Account" before transfer of any residual amount to the PSDF.
- 18.3 The bank interest and the interest received due to default in payment of Deviations Charges accumulated in "Regional Deviation and Ancillary Service Pool Account" shall also be considered as surplus along with principal amount for payment available in Regional Deviation and Ancillary Service Pool Account.
- 18.4 The Deviation and Ancillary Service Pool Account shall be charged for the full cost of despatched SRAS-Up including the energy charge or the compensation charge, as the case may be, for every time-block on a regional basis as well as the incentive for SRAS, payable to the concerned SRAS Provider



- 18.5 SRAS Provider shall pay back to the respective "Deviation and Ancillary Service Pool Account", at the rate of their variable charge or compensation charge, as the case may be, for the SRAS-Down MW quantum despatched for every 15 minutes time block.
- 18.6 The concerned RPC, using block wise schedules SRAS-Up/Down provided by concerned RLDC on weekly basis, shall compute and furnish the following details along with the DSM Account under separate account head of SRAS:
- 18.6.1 Total Energy scheduled in SRAS-Up of each SRAS-Provider.
- 18.6.2 Variable charges/commitment charges payable to SRAS providers from the pool in case of SRAS-Up
- 18.6.3 Variable charges/commitment charges payable by SRAS providers to the pool in case of DOWN regulation.
- 18.6.4 Incentive details of each SRAS-Provider based on the performance
- 18.7 The Payment to SRAS Provider(s) shall be made on net basis.
- 18.9 Any surplus accumulated in Deviation and Ancillary Service Pool Account due despatch of SRAS-Down after adjusting the payment liability of SRAS-Up provider(s) or interest accumulated due to delay in payment received from SRAS-Up provider (s) shall not be treated as monthly surplus accumulated in Deviation and Ancillary Service Pool Account and shall be retained in Deviation and Ancillary Service Pool Account for onwards settlement of Ancillary Service.
- 18.10 In case of deficit in the Deviation and Ancillary Service Pool Account for payment to SRAS Providers, surplus amount available in other region's Deviation and Ancillary Service Pool Account shall be used for such payment.
- 18.11 In case of SRAS provider to receive charges from respective DAS Pool Account on net basis, then, payment to the concerned SRAS provider shall be made within 15 (fifteen) days of the issue of statement of SRAS Account by the respective RPC.
- 18.12 In case of SRAS Provider to pay back to respective DAS Pool Account on net basis, then, concerned SRAS provider shall pay back within 10 (ten) days of the issue of statement of SRAS Account by the concerned RPC.
- 18.13 If payments to the SRAS Provider are delayed beyond Fifteen (15) days from the date of issue of the statement by the respective RPC, the SRAS Provider shall be paid simple interest @ 0.04% for each day of delay.



- 18.14 If payments by the SRAS Provider are delayed beyond ten (10) days from the date of issue of the statement by the Secretariat of the respective Regional Power Committee, the defaulting SRAS Provider shall pay simple interest @ 0.04% for each day of delay.
- 18.15 Liability to pay interest for the delay in payments to the "DAS Pool Account" shall remain till interest is not paid; irrespective of the fact that SRAS-Up Providers who have to receive payments have been paid from the "Regional DAS Pool Account Fund" in part or full.
- 18.16 The details of interest statement shall be prepared by the respective RPCs as per details received from concerned RLDCs.
- 18.17 Compensation due to Part Load Operation or any other charges not specified in the CERC (Ancillary Services) Regulations, 2022, shall not be payable to the SRAS providers for providing SRAS.
- 18.18 The quantum of schedule under SRAS Up and Down shall not be considered for the purposes of incentive calculation for the SRAS Provider by the concerned RPC.
- 18.19 Quarterly reconciliation of the SRAS Account shall be done by the respective RLDCs with the SRAS Providers.

19.0 Revision of the procedures

Notwithstanding anything contained in this Procedure, NLDC/RLDCs may take appropriate decisions in the interest of System Operation. Such decisions shall be taken under intimation to CERC and the procedure shall be modified/amended with the information to the CERC, as necessary.



Annexure – I: Technical and Commercial Parameters of SRAS Providers

Hydro Generator Details for Participation in Secondary Reserve Ancillary Service Provider (SRAS)		
From: (Name of SRAS Provider Generating Station) / (Name of Owner Organization)		
To: NRPC/WRPC/SRPC/ERPC/NERPC		
Validity of the Information From: 16/mm/yyyy To: 15/mm/yyyy		
Date: dd/mm/yyyy		
(Name of Hydro Electric Plant, Installed Capacity and Owner Organization)		
S.No	Title/Parameters	Values/Data/Information
1	Number of Generating Units (e.g. 1 x 100 MW + 2 x 250 MW)	
2	Auxiliary consumption (%)	
3	Type of Plant (RoR, Pondage or Reservoir)	
4	Installed Capacity of Unit (MW) - P	
5	Start time for each unit (Standstill to Synchronization of unit to grid) (in minutes)	
6	Which value (Cumecs/MW) is used for declaring MWh capability?	
7	Minimum load at which unit can stably run after synchronization - Unitwise (P1) (in MW)	
8	Forbidden zones or high cavitation zones - Unitwise (From MW to MW) - P2 to P3	
9	Maximum loading possible on unit (continuous) (P4)	
10	Unit-wise Cumecs/MW for P, P1,P2,P3 and P4 generation level as well as cumecs from standstill to synchronization.	
11	Maximum possible Ex-bus injection (MW) (including overload if any)	
12	Fixed Cost (paise / kWh upto one decimal place)	
13	Variable Cost (paise / kWh upto one decimal place)	
14	Ramp-Up Rate (MW/Min) for each unit	
15	Ramp-Down Rate (MW/Min) for each unit	
16	Requirement of Tandem Operation of the Plant (If Yes, with which plant and details and its Ratio)	
17	Present Governor Droop Setting (Unit-wise)	



18	Considering all the constraints, how much further droop setting can be improved and range thereof	
19	Blackstart Facility availability (Yes/No)	
20	Any Other Information including the constraints (Time-specific, Location-Specific, Event Specific, Unit-Specific, etc.)	
Thermal Generator Details for Participation in Secondary Reserve Ancillary Service Provider (SRAS)		
From: (Name of SRAS Provider Generating Station) / (Name of Owner Organization)		
To: NRPC/WRPC/SRPC/ERPC/NERPC		
Format SRAS: Generator Details by SRAS Provider (Thermal/Gas)		
Validity of the Information From: 16/mm/yyyy To: 15/mm/yyyy		
Date: dd/mm/yyyy		
S.No	Title/Parameters	Values/Data
.		
1	Number of Generating Units (e.g. 1 x 210 MW + 2 x 500 MW)	
2	Total Installed Capacity (MW)	
3	Auxiliary consumption (%)	
4	Maximum possible Ex-bus injection (MW) (including overload if any)	
5	Technical Minimum (MW)	
6	Type of Fuel	
7	Region	
8	Bid area	
9	Fixed Cost (paise / kWh upto one decimal place)	
10	Variable Cost (paise / kWh upto one decimal place)	
11	Ramp-Up Rate (MW/Min) for each unit	
12	Ramp-Down Rate (MW/Min) for each unit	
13	Start-up Time from Cold Start (in Min) & Warm Start of each unit	
14	Any other information	

Annexure-II: SOP for AGC Communication Providers

Standard Operating Procedure for AGC Communication Failure Identification

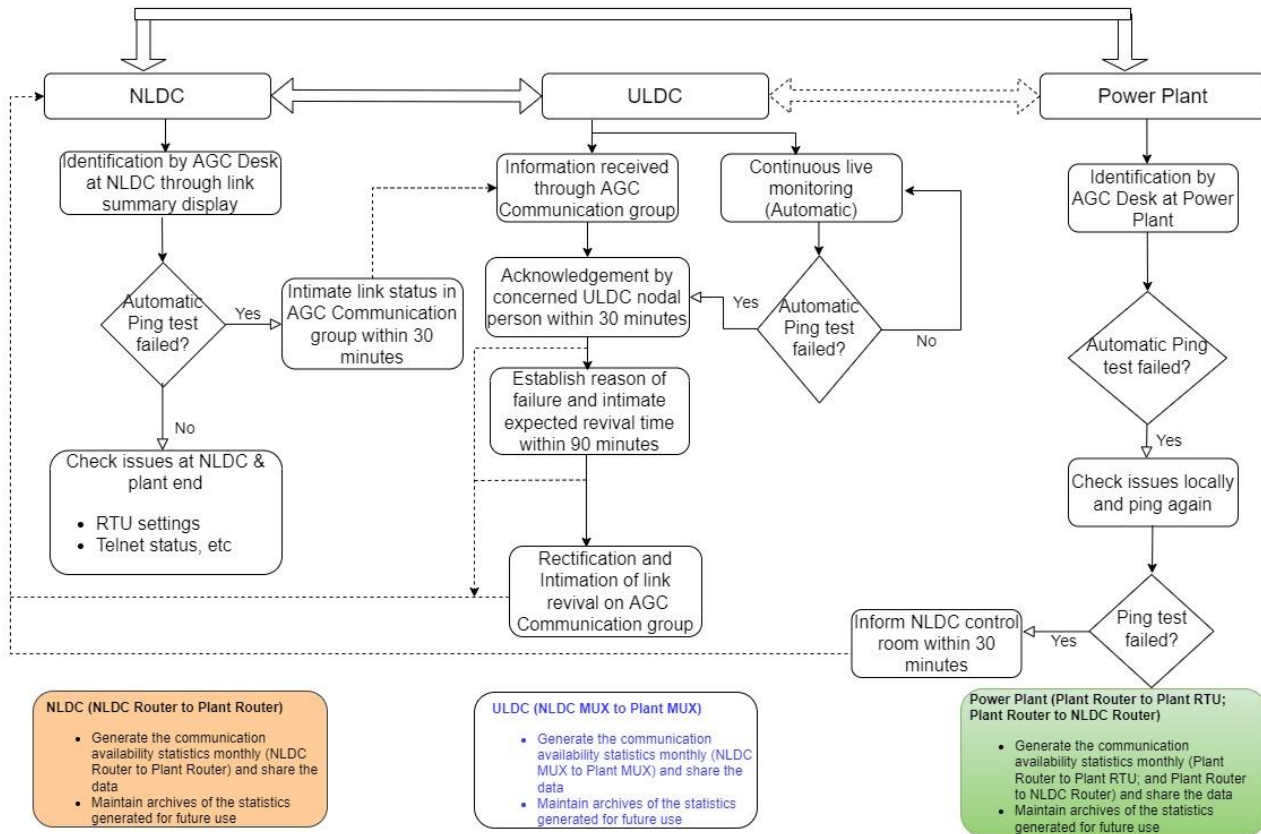



Annexure-III: Open Loop and Closed Loop Testing Procedures

Open-Loop Test Procedure for

Power Plants under Automatic Control Generation (AGC)

Efficacy of the power plant model in the AGC software and the power plants response to AGC commands is first checked through Open Loop Testing (OLT). In the OLT, AGC software generates setpoint obeying all the limits and setpoint is also sent to the power plant. But, this AGC signal "DeltaP" is not fed to power plant DCS. Before start of the test, procedure for OLT is also circulated to the power plants which is given below.

1. Every signal in predefined signal list may be validated through verbal confirmation.
 - a. Signal list may be kept ready by NLDC and Power plant before starting the process.
 - b. Power plant executive to be present in control room with access to unit Digital Control System (DCS) and AGC Remote Terminal Unit (RTU) HMI
 - c. NLDC executive to be monitoring AGC application
2. Simulate communication failure and check if Plant DeltaP analog becomes zero
 - a. Power plant to create simulated communication failure (remove cable etc.)
 - b. Power plant to correct the logic if DeltaP analog does not become zero
 - c. NLDC to create simulated communication failure
 - d. Power plant to correct the logic if DeltaP analog does not become zero
3. Simulate AGC Suspend status and check if Plant DeltaP analog becomes zero
 - a. NLDC to create simulated AGC Suspend state
 - b. Power Plant to correct the logic if DeltaP analog does not become zero
4. Toggle AGC from Remote to Local status and check if Plant DeltaP analog becomes zero
 - a. Power Plant to create simulated Local and Remote states
 - b. NLDC to concur change in Local and Remote states
 - c. Power Plant to correct the logic if DeltaP analog does not become zero during Local state
5. Setup unit capability limits. For thermal plants, default limits shall be Max = unit's gross DC on bar. Min = 55% Max. Setup distribution factors. Default = (1/units on bar). For hydro plants P1 (min), P2 -P3 (forbidden zone) and P4 (max) may be checked.
 - a. Power plant to test using maximum limit less than unit set point
 - i. NLDC to check corresponding variation in DeltaP feedback signals
 - b. Power plant to test using minimum limit more than unit set point
 - i. NLDC to check corresponding variation in DeltaP feedback signals
 - c. Change distribution factors and check if same is reflecting in NLDC
6. NLDC to explain the process for changing setting from 'Local' to 'Remote'. Note that before closed loop control, either keep the machine in 'dummy Remote' or in 'Local'.



- a. Local to Remote toggle is a manual process to be adopted by the power plant, only after code exchange with NLDC.
 - b. Remote to Local can be done by the power plant without prior code exchange in case of emergency. But post-facto code exchange has to be done. For planned remote to local, code exchange is a must.
7. Account data verification (1-week process)
- i. Understand the account data format circulated to plants from NLDC
 - a. 5 min MWh, 15 min MWh
 - ii. Data may be sent to NLDC over email on daily basis for one week
 - iii. NLDC to verify that the account data archived at NLDC and received through mail from power plant are matching. Revert to power plant for corrections if needed.
8. Maintain max and min limits in unit DCS. Important before closed loop operation from plant safety perspective.

In addition to the plant max, min, ramp and other limits, response of the power plant to the AGC Suspend Status and communication failure signals are also checked in the OLT. To familiarize the power plants with the real time operations, code exchange drill can also be conducted. Dummy AGC accounts may be generated by both power plant (as per LDC format) and LDC. In case of any discrepancy, suitable actions like precision adjustment at power plant may be taken up.

Closed Loop Testing Procedure

Once the problems observed in open loop testing are addressed, Closed Loop Testing (CLT) is conducted with the power plant. In the CLT, AGC signal "DeltaP" is fed to power plant DCS and as a result the power plant is required to track 'AGC set point' instead of the power plant operator fed 'unit load set point'. Before the CLT, test procedure is circulated to the power plants which is given below,

1. Check all the Analog and Digital signals are updating correctly before the starting of the test. ----- NLDC & Power plant
2. Maximum allowed variation above or below ULSP shall be set at 50 MW per power plant. ----- NLDC
3. Maintain units in 'Local' mode ----- Power plant
4. Inform RLDCs before the start of the test -----NLDC
5. Alert ULDC / POWERGRID for ensuring uninterrupted communication. ---- ULDC, NLDC and Power plant.
6. Exchange of code between NLDC and Power plant for bringing units into 'Remote' ----
---- code by NLDC, code & action by Power plant
7. Allow the units to remain in 'Remote' un-interrupted for 45 minutes. Observe closely the variations of power plant. Power plants shall bear the deviations under DSM -----
----- NLDC & Power plant
8. In case of any abnormal behaviour by AGC, the power plant is free to take the units into 'Local' without intimation. However, code may be exchanged subsequently with NLDC. ----- Power plant



9. Simulate AGC Suspend status and check if individual unit DeltaP analog becomes zero ---- action by NLDC
10. Simulate communication failure and check if unit DeltaP analog becomes zero ---- action by NLDC
11. Toggle AGC from Remote to Local status and check if unit DeltaP analog becomes zero ---- action by Power plant.

Draft



Annexure-IV: Suggested Generic Hardware Specifications for AGC **Connecting Equipment**

The suggested hardware may be read together with the detailed signal list. Depending on the number of units and signals required, the hardware requirement changes. Power plants/entities shall procure the hardware at their own cost considering the field level requirements.

- a) Remote Terminal Unit (RTU) with a Main CPU Card, Communication Card with communication controller, DB 9 serial interface ports (101), minimum four Ethernet ports (104) interface Tx / Rx. Firmware of communication protocol should be loaded.
- b) Analog input card: 32-bit processor with at least 32 analog inputs /outputs per generating unit, with scope for expansion.
- c) Analog output card: 32-bit processor at least 16 analog outputs per generating unit, with scope for expansion.
- d) Digital input card: 32-bit processor with at least 8 digital inputs per generating unit, with scope for expansion.
- e) Digital output card: 32-bit processor with at least 4 digital output signals per generating unit, with scope for expansion. (Provision can be useful for connecting digital devices in future)
- f) Shall be capable of communicating over IEC 60870-5-104 protocol with RLDC/NLDC. Should be capable of reporting to multiple masters (at least 4) simultaneously over IEC 104.
- g) Shall have the capability of programming /parametrization, performing microprocessor level calculations and accepting logic. RAM/ flash memory may be capable of handling complex codes. (Arithmetic and logical operations like +, -, *, /, if, else, while, do, OR, AND, NOT, etc., would be needed)
- h) Shall have the capability to acquire analog inputs of standard 4-20 mA current and 0-5 Vdc etc. or raise /lower command signals from AGC server / transducer etc.
- h) Shall have GPS clock synchronisation facility as per the standard protocols.
- i) Shall operate over the Standard DC input voltage of 24-60 V DC. Shall have the capability of automatic start up following restoration of power after an outage. Internal battery backup to hold data, date/time in SOE buffer memory is needed.
- j) All Sequence of Events (SOE) shall be recorded and reported to RLDCs/NLDC.
- k) Shall be capable of storing data on an external memory device.
- l) Shall have communication interfaces via insert- able serial interface modules for Ethernet.
- m) The associated system at power plants end shall be able to log / record the AGC signal / command from NLDC / RLDC (for the station before bifurcation) at an appropriate interval (say 2 sec or configurable) and shall integrate the AGC command over a period of 1 min, 5 min and 15 min period or user configurable period. The

integrated value of AGC command will be stored in the data base with GPS time stamping.

n) Minimum two Line interface units (LIU), network switches along with ethernet ports, router cum firewall and patch cards, as per the assessment & requirement.

o) Optical fibre cabling (through redundant and alternate paths) from the nearest wideband node up to the unit /plant control room. Shall ensure necessary equipment at wide band node switch yard for interfacing with the available ports of CTU/POWERGRID. Shall include necessary accessories to achieve communication redundancy at RTU and switchyard.

q) PC and related software (Windows, MS Excel, Antivirus, etc.) for entering distribution factor as well as storing /logging the data as mentioned above.

r) Shall have the capability to assign a minimum of two IPs (dual IPs) to each ethernet port of the RTU.

A symbolic architecture is provided below.

AGC Communication Architecture

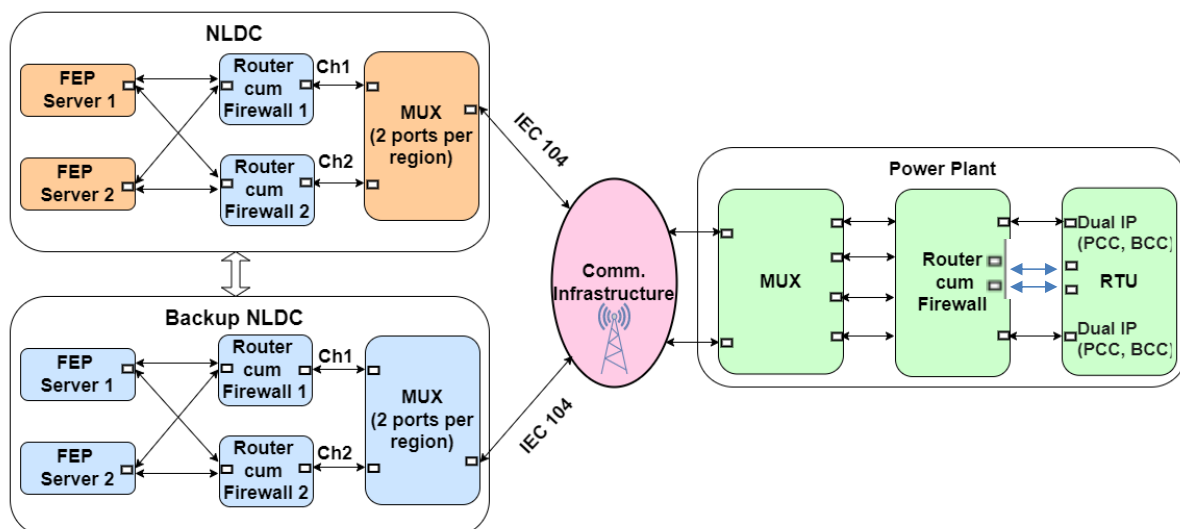

FEP: Front End Processor; SCADA application for interacting with RTUs for signal exchange

RTU: Remote Terminal Unit. AGC specific

MUX: Multiplexer

PCC: Primary Control Centre. NLDC; BCC: Backup Control Centre. Backup NLDC

IEC 104: IEC 60870-5-104 enables communication between control station and substation via a standard TCP/IP network.

Annexure-V: Detailed Signal Lists

Detailed Signal List for conventional generation

The following signals would be handled in AGC for control and monitoring purposes. Apart from the below mentioned signals, some other power plant specific signals also might be needed on a case-to-case basis. Expansion and spares included in procurement may be used for the same. Detailed logics to be implemented at each power plant and its individual generating units are given below.

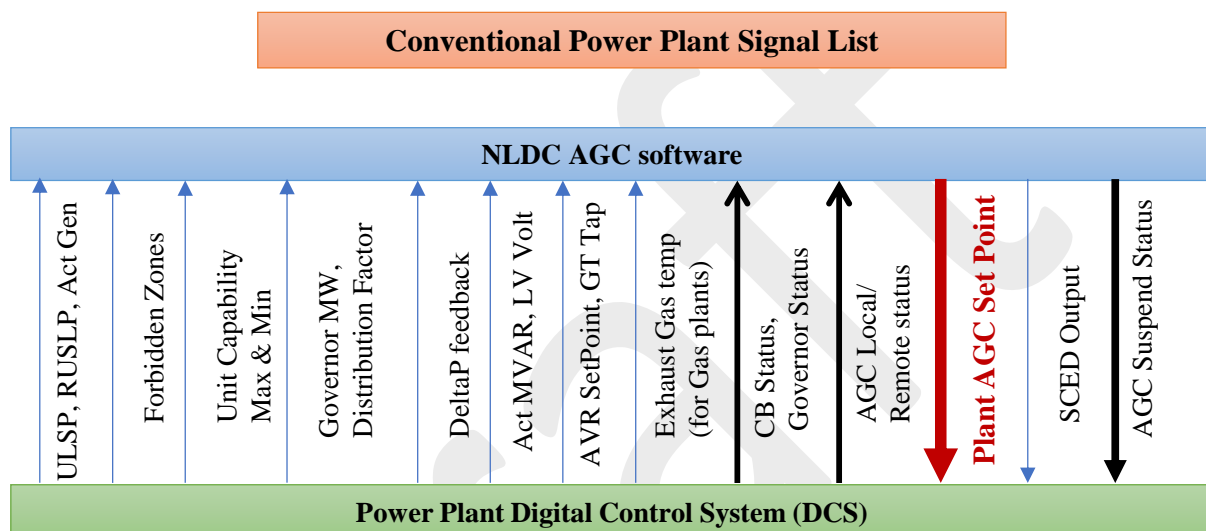

A) Analog data to be sent from power plants to NLDC

1. Unit Load Set Point (ULSP) MW or Base Point

It is the unit-wise manual entry done by the plant shift engineer/operator in the digital control system (DCS) of the generating unit. ULSP is an ex-generating unit value entered by the power plant shift engineer in the DCS for each time block calculated by adding auxiliary power consumption of the unit to the ex-bus schedule provided by the RLDC. Note that the ex-bus schedule is provided for the total power plant by the RLDC; this is distributed in between the on bar generating units by the plant operator considering on-site constraints. To be entered for each individual unit.

2. Ramp Limited Unit Load Set Point (RULSP)

Ramp Limited Unit Load Set Point (ULSP) is the unit-wise continuous ramp rate limited signal produced based on the manual entry done by the plant shift engineer/operator in the digital control system (DCS) of the generating unit. RULSP is an ex-generating unit value derived from the ULSP entered by the power plant shift engineer in the DCS for each time block calculated by adding auxiliary power consumption of the unit to



the ex-bus schedule provided by the RLDC. Typically, the ramp rate limitation for each unit is $1\% \times \text{Installed Capacity} / \text{min}$ of the unit.

3. Actual Generation MW

Actual generation in MW is the ex-generating unit value available in the DCS for every generating unit.

4. Cap_Max in MW

It is the ex-generating unit capability to be updated by the power plant operator by distributing the ex-bus declared capability amongst the on-bar generating units and adding the respective auxiliary consumption. This shall be entered by the power plant operator in the DCS / HMI. To be entered for each individual unit.

5. Cap_Min in MW

It is the minimum limit to be entered by the power plant operator in the DCS / HMI. To be entered for each individual unit.

Note: Cap_Max and Cap_Min values summed up for the total plant are used by the AGC software at NLDC to limit the final AGC Set Point before sending to the power plant. Cap_Max and Cap_Min are manually entered values (as decided during the October 2019 meetings with thermal power plants).

6. RGMO/FGMO/Governor input to governor

This signal is the MW input to the governor from the output of the RGMO control block in the DCS. Alternatively put, this signal in MW is the generation of the unit caused by primary frequency response alone.

7. Delta P feedback

Delta P feedback signal shall be taken from the DCS. In the unit DCS, Delta P (calculated in RTU or DCS) would be added to ULSP to calculate the final unit AGC set point. There can be limits enforced for each unit by the power plant to restrict the total MW load set point input reaching master control. Delta P feedback shall be calculated after the limits are enforced.

Delta P feedback = (Unit AGC Set Point after limits are enforced at unit – ULSP)

The reason "Unit AGC Set Point after limits are enforced at unit" is needed is to exactly capture the MW quantum reaching the master control of the unit after adding AGC



input to ULSP. This signal would be used in accounting and verification of the data exchange between NLDC and power plant, and is critical.

8. Flexible DeltaP Limit (MW)

Flexible DeltaP Limit (F MW) has to be telemetered by the power plants to control centre, which ensures that the AGC SetPoint can only be in between (ULSP)+/- (F) MW. Power plants can change the limits manually as needed.

This limit would be honored by the AGC software at LDC while sending AGC Set Point. This limit would be a MW value per unit each for up and down AGC regulation.

9. Reactive Power Actual MVAR

Actual MVAR reactive power absorbed or delivered by the unit.

10. AVR Voltage Set Point

Voltage set point of the automatic voltage regulator / exciter.

11. Low Voltage (LV) side Actual Voltage

Voltage at the LV side of the generating unit.

12. Generator Transformer (GT) Tap Position

Tap position setting of the generator transformer.

13. Distribution Factor (fraction for distribution of AGC DeltaP in between the units of the power plant)

It is the fraction by which the power plant operator divides the AGC regulation signal ($\Delta P = \text{Plant AGC Set Point} - \text{Plant ULSP}$) in between the generating units. This signal is available in the user interface of the AGC remote terminal unit (RTU). The sum of all distribution factors of generating units in a power plant must be 1 (this feature can be automated or kept as manual entry).

Additional Analog inputs from Hydro power plants

14. P1 in MW

It is the minimum value after synchronization to be entered by the plant operator in the DCS/HMI. To be entered for each individual unit.



15.P2 - P3 in MW (Forbidden zones or high cavitation zones)

P2 – P3 is the forbidden zone / cavitation zone for all the Francis turbine based hydro power plants entered by the power plant operator in the DCS/HMI. To be entered for each individual unit.

16.P4 in MW

It is the MW value up to which a unit can be overloaded. To be entered by the plant operator in the DCS/HMI for each individual unit.

17.Declared Energy for the day in million units (MU)

18.Schedule Energy in MU (Cumulative for the day)

19.Water gross head (m)

Additional Analog inputs from Gas power plants

20.Reference exhaust gas temperature

21.Actual exhaust gas temperature

B) Digital Input data required per generating unit

1. Circuit Breaker Status on/off: To understand whether the unit is on bar or off bar. Ensuring the quality of this information is also very critical for AGC. This is a double point signal (2 - CB closed, 1 - CB open, 0 - in between)
2. Governor status on/off: To understand whether the unit is providing primary response also.
3. AGC Local/Remote:

The manual choice to take the unit into local or remote is with the power plant shift engineer through DCS. A suitable user interface has been developed by the instrumentation team at every power plant for taking units into Local/Remote. This is a single-point digital signal (0 – Local, 1- Remote).

“Remote” means unit Delta P shall be added to ULSP before processing the signal for maximum and minimum limits and further sending it to master control. Thus, if a unit is in Remote, it is ready to accept and respond to AGC signals. “Local” means unit Delta P shall not be added to ULSP. This choice



can be because of onsite problems, non-readiness to accept AGC signals, prolonged communication failure, etc.

Additional Digital inputs from Hydro power plants

4. Pumping Status on/off: for pumped hydro power plants

C) Data sent from NLDC to Power plant

1. AGC Set Point – Analog

AGC set point shall be provided for the total power plant for thermal generating units. This AGC set point is the main input to the power plants from AGC which will be used for calculation of Plant Delta P = Plant AGC Set point – Plant ULSP.

- A feedback signal of AGC Set Point would be needed from the power plant to LDC through a separate address, called as Setter Feedback, which is used by AGC software as a handshake signal for control monitoring.

2. AGC Suspend Status – Digital double point signal

Sometimes AGC needs to be suspended by NLDC for reasons like intermittent communication, reboots, updations etc. This information would be sent as a digital status double point (2- means AGC not suspended, 1-means AGC suspended, 0-in between status)

- A feedback signal of AGC Suspend Status would be needed from the power plant to LDC through a separate address, called as Status Feedback, which is used by AGC software as a handshake signal for control monitoring.

3. SCED schedule - Analog

Real time ex-bus Net Schedule of the power plant would be provided by LDC to the power plants via AGC channel. The power plants may use this signal for monitoring/information purposes and not for control purposes as of now. This analog



signal is the RLDC Net Ex-bus Schedule of the power plant including RTM, RRAS and SCED components.

- The feedback for the SCED signal shall be telemetered by the power plant to LDC through a separate address.

D) Basic logics to be implemented at the power plant RTU and DCS

The basic logics given below may be implemented for safe operation. Apart from these, some other logics may need to be implemented on case to case basis.

- Plant DeltaP analog is calculated as, $Plant\ Delta\ P = (Plant\ AGC\ Set\ Point - \sum_1^n(ULSP_n)) * AGC\ Suspend\ Status * Communication\ Failure$
- For Distribution Factor Analog Input of 'n' units, check $\sum_1^n(Distribution\ Factor_n) = 1$
- $Unit\ Delta\ P_n = Plant\ Delta\ P * Distribution\ Factor_n * AGC\ Local\ Remote_n$
- $Unit\ AGC\ Set\ Point_n = Unit\ Delta\ P_n + ULSP_n$
- Enforce minimum and maximum limits at each unit to process $Unit\ AGC\ Set\ Point_n$ and convert it to $Unit\ AGC\ Set\ Point\ after\ Limits_n$
- $Unit\ Delta\ P\ Feedback_n = Unit\ AGC\ Set\ Point\ after\ Limits_n - ULSP_n$
- Scheduled Energy (Cumulative MU) for Hydro is calculated as $\sum_{t=1}^{TB}(Scheduled\ MW/4000)$

Where TB is the current time block.

- For hydro power plants, NLDC can send directly $Unit\ AGC\ Set\ Point_n$ for each unit. Hydro plant operator shall be provided with option to select one of the operating modes specified below:
 - Plant AGC set point will be communicated from NLDC and use specified distribution factors for calculating unit Delta P as above.
 - Unit AGC set points communicated from NLDC will be used for calculating unit Delta P



- Unit AGC set points communicated from NLDC be converted to Plant AGC set point and use specified distribution factors for calculating unit Delta P.
- i) To detect communication failure and convert Plant DeltaP analog output to zero
- j) To detect AGC Suspend status and convert Plant DeltaP analog output to zero
- k) To detect AGC Local status and convert Plant DeltaP analog output to zero.
- l) Automation of Distribution Factor, Cap_Max, Cap_Min and ULSP:

The actions while taking the units into Local, Remote, Shutdown, Communication failure, and AGC Suspending shall be automated. For the units which are on bar and in "Local", Cap_Max = Cap_Min = ULSP shall be done. Distribution Factor has to be changed accordingly. If CB is OFF, ULSP=0 has to be made for that unit. A new intermediate signal UADD may be configured. As many UADD signals may be derived for as many numbers of units.

UADD = (unit CB status ON/OFF) && (unit Local Remote status ON, OFF).

If either unit CB status=OFF or LR status=OFF, then UADD=0, else UADD=1.

An example table for a 3-unit plant is given below. The changes in Cap_Max, Cap_Min, Distribution Factor and ULSP may be automated based on the UADD state table.

S. No	UADD			Logic	Distribution factor			(Cap_Max, Cap_Min) Limits		
	U1	U2	U3		U1	U2	U3	U1	U2	U3
1	0	0	0	If U1ADD == 0 && U2ADD == 0 && U3ADD == 0	0	0	0	(ULSP, ULSP)	(ULSP, ULSP)	(ULSP, ULSP)
2	0	0	1	If U1ADD == 0 && U2ADD == 0 && U3ADD == 1	0	0	1	(ULSP, ULSP)	(ULSP, ULSP)	(Cap_Max, Cap_Min)
3	0	1	0	If U1ADD == 0 && U2ADD == 1 && U3ADD == 0	0	1	0	(ULSP, ULSP)	(Cap_Max, Cap_Min)	(ULSP, ULSP)

S. No	UADD			Logic	Distribution factor			(Cap_Max, Cap_Min) Limits		
	U1	U2	U3		U1	U2	U3	U1	U2	U3
4	0	1	1	If U1ADD == 0 && U2ADD == 1 && U3ADD == 1	0	0.5	0.5	(ULSP, ULSP)	(Cap_Max, Cap_Min)	(Cap_Max, Cap_Min)
5	1	0	0	If U1ADD == 1 && U2ADD == 0 && U3ADD == 0	1	0	0	(Cap_Max, Cap_Min)	(ULSP, ULSP)	(ULSP, ULSP)
6	1	0	1	If U1ADD == 1 && U2ADD == 0 && U3ADD == 1	0.5	0	0.5	(Cap_Max, Cap_Min)	(ULSP, ULSP)	(Cap_Max, Cap_Min)
7	1	1	0	If U1ADD == 1 && U2ADD == 1 && U3ADD == 0	0.5	0.5	0	(Cap_Max, Cap_Min)	(Cap_Max, Cap_Min)	(ULSP, ULSP)
8	1	1	1	If U1ADD == 1 && U2ADD == 1 && U3ADD == 1	0.33	0.33	0.33	(Cap_Max, Cap_Min)	(Cap_Max, Cap_Min)	(Cap_Max, Cap_Min)

m) Ramp limit on DeltaP

During the below status changes, DeltaP shall be made zero automatically.

- Remote to Local
- AGC Suspend OFF to ON
- AGC communication Status ON to OFF

The movement of DeltaP to zero shall be restricted to 1%*Unit IC/min as the ramp rate limit in such cases.



Battery Energy Storage System (BESS) Signal List

Note: The architecture and signal list presented in this Annexure are provisional as sufficient experience of Solar AGC is yet to be obtained. In view of this, plants may note that spares, flexibility and last mile innovations may be needed during actual implementation.

a. Maximum MW permissible

It is the maximum MW which can be discharged (+ve value) / charged (-ve value) by the BESS at any particular point of time.

b. Minimum MW permissible

It is the minimum MW which can be discharged (+ve value) / charged (-ve value) by the BESS at any particular point of time.

c. Ramp rate up permissible

It is the maximum MW/min with which the BESS can be discharged (+ve value) by AGC at any particular point of time.

d. Ramp rate down permissible

It is the maximum MW/min with which the BESS can be charged (-ve value) by AGC at any particular point of time.

e. Actual MW

It is the actual generation MW value of the BESS.

f. Scheduled MW or ULSP

It is the scheduled generation value of the BESS, for fulfilling the stakeholder contracted energy/power. It is analogous to Unit Load Set-Point (ULSP) or RLDC schedule of a conventional power plant. Without Ancillary Services (SRAS and TRAS), BESS would discharge/charge this MW value. This Scheduled MW (ULSP) would be positive value while discharging, and negative value while charging.

g. Circuit Breaker status

To understand whether the BESS is on or off. Ensuring the quality of this information is also very critical for AGC. This is a double point signal (2 - CB closed, 1 - CB open, 0 - in between).

h. Local/Remote status

The manual choice to take the BESS into local or remote is with the plant shift engineer through DCS. A suitable user interface shall be developed by the instrumentation team at every plant for taking BESS into Local/Remote. This is a single-point digital signal (0 – Local, 1- Remote).



“Remote” means unit Delta P shall be added to ULSP before processing the signal for maximum and minimum limits and further sending it to master control. Thus, if a BESS is in Remote, it is ready to accept and respond to AGC signals. “Local” means block Delta P shall not be added to ULSP. This choice can be because of onsite problems, non-readiness to accept AGC signals, prolonged communication failure, etc.

i. Minimum State of Charge SOC % permissible

It is the minimum value of SOC % up to which a BESS can be discharged. Default value would be 10-20%.

j. Actual State of Charge SOC %

It is the current value of SOC % of the BESS. Beyond Maximum and Minimum SoC%, AGC software would stop sending AGC signals to BESS.

k. Scheduled Cycle (0-100%) count per day no.s

It is the number of round-trip cycles of BESS allowed per day. Default value would be 2-3 cycles/day.

l. Actual Cycle (0-100%) count per day no.s

It is the number of round-trip cycles of BESS exhausted at any point of time in the day, after 0000 hrs of that day. If the Actual Cycles count becomes equal to or greater than Scheduled Cycle count, then AGC software would stop sending AGC signals to BESS.

m. BESS forbidden zones

Information regarding any forbidden zones in which BESS should not be operated. This is analogous to the prohibited zones of Francis Hydro Turbines.

n. AGC Set Point MW from LDC to BESS

This is the signal from LDC to BESS, for the purpose of AGC control. This signal would contain the components of Scheduled MW and a correction corresponding to Area Control Error (ACE), and honours the limits mentioned above. The set point would be positive value while discharging, and negative value while charging.

The following signals would also be needed for monitoring purpose

- o. Actual MVAR
- p. Auxiliary Consumption MW
- q. BESS Temperature
- r. Ambient Temperature
- s. Voltage (kV) at grid level
- t. Voltage (V) at BESS LV side
- u. Feedback/handshake signals
- v. Primary Response MW

- w. Primary Response ON/OFF status
- x. Tap position

Solar Generators Signal List

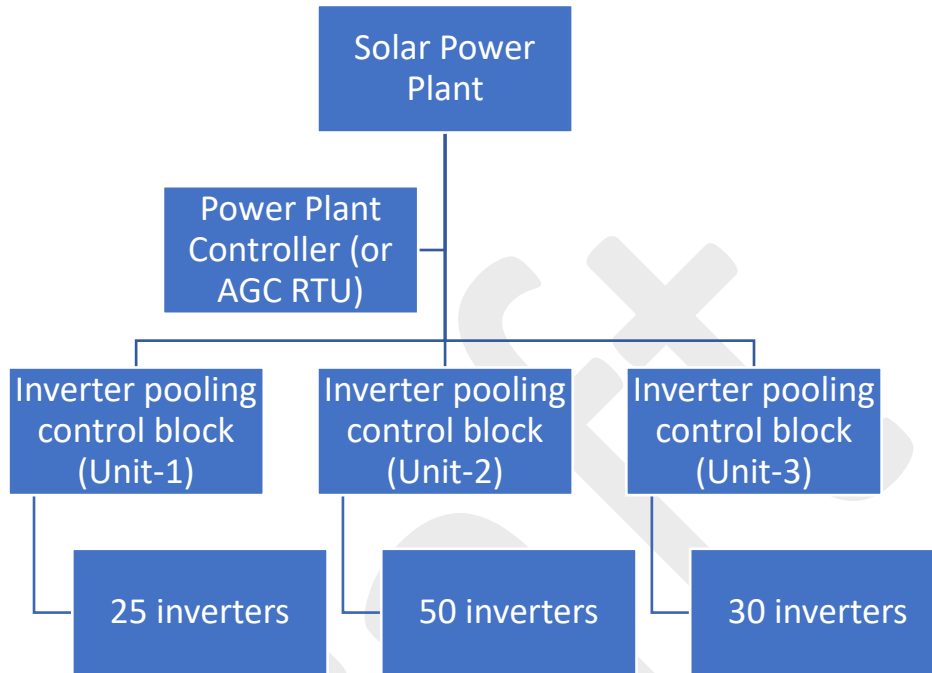

AGC Solar Pilot – Design



AGC control based on real time monitoring of reference inverters (un-controlled inverters) where controlled inverters only will respond for AGC signals.

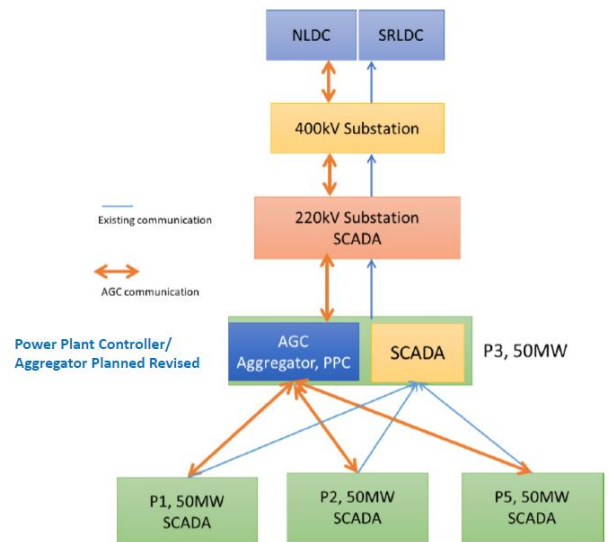

Note: The architecture and signal list presented in this Annexure are provisional as sufficient experience of Solar AGC is yet to be obtained. In view of this, plants may note that spares, flexibility and last mile innovations may be needed during actual implementation.



A) Analog data to be sent from power plants to LDC per block

1. ULSP MW:

It is a block-wise MW value calculated by assuming all the inverters as reference inverters. Thus, ULSP value is calculated block wise by adding the MPPT MW values of all the inverters in the block. Each block is analogous to a unit in the conventional power plant.

2. Actual generation MW:

It is the block-wise actual generation value in MW.

3. Reactive Power Actual MVAR

Actual MVAR reactive power absorbed or delivered by the block.

4. Delta P feedback

Delta P feedback signal shall be taken from the DCS. In the block DCS, Delta P (calculated in RTU or DCS) would be added to ULSP to calculate the final block AGC set point. There can be limits enforced for each block by the power plant to restrict the total MW load set point input reaching master control. Delta P feedback shall be calculated after the limits are enforced.

$\text{Delta P feedback} = (\text{Unit AGC Set Point after limits are enforced at block} - \text{ULSP})$

The reason "Unit AGC Set Point after limits are enforced at unit" is needed is to exactly capture the MW quantum reaching the master control of the unit after adding AGC input to ULSP. This signal would be used in accounting and verification of the data exchange between NLDC and solar generator, and is critical.

5. Cap_Max in MW

It is the maximum limit of the block to be updated by the plant operator corresponding to the number of inverters in the block. This shall be entered by the plant operator in the DCS / HMI. To be entered for each individual block. This value can be the same as MPPT, by default.

6. Cap_Min in MW

It is the minimum limit corresponding to the number of inverters in the block. To be entered by the power plant operator in the DCS / HMI for each individual block. This value can be $10\% * \text{MPPT}$, by default.

7. Offset or Max Curtailment in MW

It is the maximum curtailment allowed for each block, entered by the plant operator. Percent curtailment of actual generation is to be converted to MW value, wherever conversion is needed. Default value can be 90%, converted to MW.



8. Low Voltage (LV) side Actual Voltage in kV

Voltage at the LV side of each block.

9. High Voltage (HV) side Actual Voltage in kV

Voltage at the HV side of each block.

10. Reference Inverters Number

It is the number of reference inverters to be entered for each individual block. Percent reference inverters to be converted to number of reference inverters by the plant operator, wherever conversion is needed.

11. Controllable Inverters Number

It is the number of controllable inverters to be entered for each individual block. Percent controllable inverters to be converted to number of controllable inverters by the plant operator, wherever conversion is needed.

12. Reference Inverters MW

It is the block-wise MW value corresponding to the number of reference inverters.

13. Controllable Inverters MW

It is the block-wise MW value corresponding to the number of controllable inverters.

14. MPPT Loading in MW

It is the Maximum Power Point up to which a block can operate at any time. ULSP value is the same value as this, as of now. This signal is a spare signal considering the possible flexibility provisions in future RE scheduling.

B) Digital Input data required per block

1. Circuit Breaker Status on/off: To understand whether the block is on or off. Ensuring the quality of this information is also very critical for AGC. This is a double point signal (2 - CB closed, 1 - CB open, 0 - in between).



2. AGC Local/Remote:

The manual choice to take the unit into local or remote is with the plant shift engineer through DCS. A suitable user interface shall be developed by the instrumentation team at every plant for taking blocks into Local/Remote. This is a single-point digital signal (0 – Local, 1- Remote).

“Remote” means unit Delta P shall be added to ULSP before processing the signal for maximum and minimum limits and further sending it to master control. Thus, if a block is in Remote, it is ready to accept and respond to AGC signals. “Local” means block Delta P shall not be added to ULSP. This choice can be because of onsite problems, non-readiness to accept AGC signals, prolonged communication failure, etc.

3. Plant AGC Selection Mode:

Input from Plant to LDC (to monitor) whether AGC is in Plant mode or Unit mode. In case the power plant has power plant controller, plant mode is convenient. Else, in cases where individual block controls are existing, Unit mode would be used on a case to case basis.

4. Plant Voltage Selection Mode:

Input from Plant to LDC (to monitor) whether Plant is in Voltage Control mode or Power Factor mode

C) Data sent from LDC to Power plant

1. AGC Set Point – Analog

AGC set point shall be provided for the total power plant for thermal generating units. This AGC set point is the main input to the power plants from AGC which will be used for calculation of Plant Delta P = Plant AGC Set point – Plant ULSP.

2. AGC Suspend Status – Digital double point signal

Sometimes AGC needs to be suspended by LDC for reasons like intermittent communication, reboots, updations etc. This information would be sent as a digital status double point (2- means AGC not suspended, 1-means AGC suspended, 0-in between status)



Annexure-VI: Guideline for Calculation and Monitoring of Area Control Error (ACE)



**National Load Despatch Centre
Power System Operation Corporation Limited**

Guideline for Calculation and Monitoring of Area Control Error

This document provides the detailed guidelines to be uniformly adopted by the NLDC, RLDCs, SLDCs, and REMCs for measurement, calculation, monitoring, and archival of Frequency, Tie-Line Flows, Frequency Bias, Metering Errors, and Area Control Error (ACE). ACE is an important parameter which depicts the health of the power system. This document enables uniform notation for ACE, thereby allowing all the load despatch control rooms pan India to pass on information about this grid security aspect with one another.

Table of the Contents

- 1. Formula of Area Control Error (ACE)**
 - 2. Measurement of Frequency**
 - 2.1. Choosing the master list of redundant frequency sources
 - 2.2. Location of redundant frequency sources and host server
 - 2.3. Algorithm for selecting the Primary Frequency Source
 - 3. Measurement of Tie-Line Flows**
 - 3.1. Actual Tie-Line Flows
 - 3.2. Scheduled Tie-Line Flows
 - 4. Assessment of Frequency Bias**
 - 4.1. Bf value assessment
 - 4.2. Bf update timing
 - 5. Measurement of Metering Errors - OFFSET**
 - 6. Calculation of ACE**
 - 7. Archival of different parameters**
 - 8. Monitoring of ACE and Suggested Corrective Actions**
 - 9. Calculating ACE for Regional Entity Control Area**
- Annexure-I.I: Sample Template for Frequency Response Characteristic Calculation**

1. Formula of Area Control Error (ACE)

The Area Control Error (ACE) for each control area¹ would be calculated at all the load despatch centres based on telemetered values and external inputs as per the below formula².

$$\text{ACE} = (I_a - I_s) - 10 * B_f * (F_a - F_s) + \text{Offset}$$

I_a = Actual net interchange in MW (positive value for export)

I_s = Scheduled net interchange in MW (positive value for export)

B_f = Frequency Bias Coefficient in MW/0.1 Hz (negative value)

F_a = Actual system frequency in Hz

F_s = Schedule system frequency in Hz (default 50 Hz)

Offset = Provision for compensating errors such as measurement error; default value zero.

In the above formula, ACE has three components as below.

1. Interchange deviation component **($I_a - I_s$)**
2. Frequency deviation component **$-10 * B_f * (F_a - F_s)$**
3. Offset or Metering Error

Sign convention adopted for interchange MW values is, positive value for export and negative value for import. B_f is a negative value. System Frequency (F_a) is a positive value, close to the National Reference Frequency³ of 50 Hz.

ACE is positive means that the control area has surplus generation and the control area's internal generation has to be backed down. ACE is negative means the control area is in deficit and the control area's internal generation has to be increased. ACE has to be driven towards zero for better frequency control and grid security.

¹ Control Area means an electrical system bounded by interconnections (tie lines), metering and telemetry which controls its generation and/or load to maintain its interchange schedule with other control areas and contributes to regulation of frequency as specified;

Definition from the Report of the Expert Group: Review of Indian Electricity Grid Code, January 2020. <https://cercind.gov.in/2020/reports/Final%20Report%20dated%202014.1.2020.pdf>

² Formula as given in the Report of the Expert Group: Review of Indian Electricity Grid Code, January 2020.

³ Defined in the Report of the Expert Group: Review of Indian Electricity Grid Code, January 2020.



2. Measurement of Frequency

System frequency is an important input for calculating ACE. Typically, ACE is used for taking generation increase/decrease actions using the below applications

- a. Secondary frequency control through AGC
- b. Tertiary frequency control through TRAS
- c. Monitoring and manual generation rescheduling

All the above three applications operate in the time frame of a few seconds to several minutes. Hence it should suffice that the system frequency signal is captured using a sampling time of a few seconds for calculation of ACE.

Suggested sampling time for frequency: 4 seconds, i.e., take a fresh frequency data point every four seconds.

2.1. Choosing the master list of redundant frequency sources

The frequency signal taken should be free from noise. To ensure the same, the signals from such stations shall be selected as the frequency sources, whose historical data is proven to be at least 99.9% noise-free in the past three months. To identify noise, the frequency data of different stations shall be plotted in a time series graph. The graph should be free from spikes. Choose 10 such stations to act as redundant frequency sources in ACE calculation. This list may be reviewed quarterly.

2.2. Location of redundant frequency sources and host server

For the applications a, b, and c, mentioned above, frequency source from any geographic location should serve the purpose as the time range of interest is in seconds. Typically, in time frame of a few seconds, all the electromagnetic transients and most of the electromechanical transients usually get damped and settled⁴. Hence, stations from different geographic locations can be chosen as redundant frequency sources. Having a mix of at least 10 redundant frequency sources from SCADA and URTDSM (PMU) is advised. Frequency data from URTDSM server are generally imported into SCADA⁵ for the purpose of ACE calculation.

⁴ For applications b & c, as the dispatches are time block-wise, there is no need of consideration about frequency oscillations. For AGC, oscillations in ACE are further smoothed by the exponential moving average filters and the PI controller (low pass filter) which are typically part of the AGC software. The integration time in AGC is in generally between 10s -120s and hence the electromechanical oscillations and any noise get further damped.

⁵ PMUs are not available on all the tie-lines. Hence calculating ACE is recommended through SCADA.

2.3. Algorithm for selecting the Primary Frequency Source

The ACE calculation program can look at the quality tags of all the redundant signals and choose one of the signals as the primary source. The update of the quality tags happens along with the sampling of the data in the EMS system, as a general practice. In case the quality of the primary frequency source becomes 'suspect', then the next signal with 'good quality tag' shall be selected as the primary frequency source automatically. This logic may be developed into the calculation program gradually, if not immediately.

Algorithm outline:

Initialize Primary Freq= 50 Hz

Initialize K=1

Initialize J=1

Initialize Flag = Good

Call Subroutine-A

Subroutine-A ()

Select the Kth frequency signal in the list as 'primary' and read its quality tag.

If the quality tag is good, set J=1, exit Subroutine-A and GOTO Subroutine-B.

If, J=11, Primary Freq = 50 Hz, exit Subroutine-A and GOTO Subroutine-B.

Else, K=K+1, J=J+1 and Call Subroutine-A.

End Subroutine-A ()

Subroutine-B ()

While Flag = Good

 Read the quality tag of the Kth signal at time t

 If the quality tag is good, t=t0+4s, Flag=Good

 Else Flag = Bad

End While

GOTO Subroutine-A

End Subroutine-B

3. Measurement of Tie-Line Flows

3.1. Actual Tie-Line Flows

Actual tie-line flows shall be sampled every 4 seconds⁶ similar to frequency and shall be used in the ACE calculation. The update of the quality tags happens along with the sampling of the data in the EMS system, as a general practice. Say, the data is acquired only every 12s by the SCADA because of delays⁷, the ACE calculation program shall repeat the data thrice in those 12s. Some Tie-Line flows have the problem of becoming suspect often. Such data should be identified and rectified immediately by following up with site/substation. It shall be ensured that the clock synchronization across all the stations taken into consideration by the respective LDC and its calibration shall be done once every year in order to ensure the synchronicity of time stamping of the collected data. Every tie-line flow can be obtained from 3 different sources viz.,

- i. Primary Side (choose the Metering End as per IEGC)
- ii. Secondary Side (side other than the Metering End as per IEGC)
- iii. State Estimator output

Primary side data shall be normally used for ACE calculation. In case the quality of the primary side becomes 'suspect', then let the ACE calculation program automatically choose the secondary side. If flow at both the ends goes suspect, use the state estimator output. If the state estimator is not running, replace the suspect data manually with 'last good value', rather than retaining garbage value. Information of manual interventions shall be monitored, carried forward and updated frequently in every shift. Sign convention adopted for interchange MW values is, positive value for export and negative value for import.

⁶ At NLDC, the tie line flow acquisition delay (around 10s) includes the delay introduced while acquiring data from RLDCs through ICCP, apart from the delay in acquiring tie line data from RTUs to the RLDCs. For other RLDCs/control areas, delay (~ 5s) is mainly introduced in acquiring tie line data from RTUs to the RLDCs. However, this data acquisition timing has to be improved further by all the control areas.

⁷ Higher updation time as well as non-simultaneity can lead to inconsistent frequency response assessment and incorrect ACE calculations. Ideal would be to have PMUs on all inter-regional lines to begin with, followed by all inter-state tie lines.



Note that all the tie-lines should be accounted for, while calculating the Net Actual Tie-Line Flow (I_a), i.e., algebraic sum of the flows. If any of the tie-lines is non-observable, the data of the same can be replaced with a fixed value as informed by site/substation telephonically to the control room.

3.2. Scheduled Tie-Line Flows

The Net Scheduled Tie-Line Flow (I_s) of a control area should generally be the output of a scheduling software program, from which the data is imported into SCADA for all the 96-time blocks. ACE is calculated using the net tie-line flow, and path-wise scheduled flows are algebraically added based on direction.

Net Scheduled Tie-Line Flow of the control area can be calculated every time block by adding the algebraic sum of scheduled MW export contracts (from the control area to all the other control areas; positive values) and the scheduled MW import contracts (to the control area from all the other control areas; negative values) and the MW sum of resultant of the virtual entities. In line with the tie-line flow convention, sign convention for TRAS Up regulation is positive, TRAS Down is negative. Note that for ACE calculation, we are interested in the net control area values, and not the path-wise values.

For example, if a particular control area imports 2000 MW from the other control areas through tie-lines, exports 500 MW to the other control areas through tie-lines, TRAS Up of 200 MW is dispatched and SCED Down of 100 MW is dispatched. Then $I_s = -2000 + 500 + 200 - 100 = -1400$ MW for that time block.

Note that the Net Scheduled Tie-Line Flow value shall be always less than the Export Available Transfer Capability (ATC) and greater than the Import ATC value. While calculating ACE, this 15-minute data has to be updated/refreshed every 4 seconds.

4. Assessment of Frequency Bias

The 2017 IEEE Task Force Report⁸ on "Measurement, Monitoring, and Reliability Issues Related to Primary Governing Frequency Response," recommends using Frequency Response Characteristic (FRC) calculated after the power and frequency transients have settled, for the Frequency Bias Coefficient (B_f) used in the ACE equation. A sample size of twenty (20) FRC events has been deemed adequate for estimating the frequency response characteristic to rule out human error. Several

⁸ IEEE Task Force Report. 2017. "Measurement, Monitoring, and Reliability Issues Related to Primary Governing Frequency Response," Technical Report PES-R-24, October.

<https://resourcecenter.ieee-pes.org/publications/technical-reports/PESTECRPTGS0001.html>



other references⁹ also have been studied, which support the IEEE Task Force Report recommendations.

FRC computation procedure has been clearly provided in the draft IEGC 2020¹⁰. A sample template for FRC assessment is enclosed as Annexure-I.I. FRC shall be computed for every control area for all events involving a sudden 1000 MW or more load/generation loss or a step change in frequency by 0.10 Hz. All these FRC values shall be archived along with date, time and reasons of the event.

4.1. Bf value assessment

In the calculation of ACE, the value of Frequency Bias Coefficient in MW/0.1 Hz (negative value) shall be based on median Frequency Response Characteristic. Median¹¹ value of the past 20 events would be used for updating the FRC. The occurrence of these 20 events is actually expected to cover the entire previous year, thereby subsuming the seasonality aspect of load and generation. Bf value shall be declared by the Nodal Agency.

4.2. Bf update timing

The Bias (Bf) value may be updated in the ACE calculations at the LDCs, once in every quarter on the 24th day of the month after the completion of the previous quarter. The literature studied and mentioned in the footnotes-6,7 suggests updating the bias values once in a year for practical power systems. However, due to the developing nature of Indian power system, a quarterly update has been suggested. For example, update the Bias (Bf) value on 25th July, after the completion of the quarter April – June. The updated Bf value in SCADA shall also be shared continuously through ICCP bottoms up, from SLDCs to RLDCs, and from

⁹ J. L. Willems, "Sensitivity Analysis of the Optimum Performance of Conventional Load-Frequency Control," in IEEE Transactions on Power Apparatus and Systems, vol. PAS-93, no. 5, pp. 1287-1291, Sept. 1974, doi: 10.1109/TPAS.1974.293852. <https://ieeexplore.ieee.org/document/4075491>

NERC, Frequency Response Standard Background Document. November, 2012.
[https://www.nerc.com/pa/Stand/Project%20200712%20Frequency%20Response%20DL/Bal-003-1-Background Document-Clean-2013 FILING.pdf](https://www.nerc.com/pa/Stand/Project%20200712%20Frequency%20Response%20DL/Bal-003-1-Background%20Document-Clean-2013%20FINAL.pdf)

P. Kundur, Power System Stability and Control, Chapter 11, McGraw-Hill, New York, 1994.

¹⁰ Report of the Expert Group: Review of Indian Electricity Grid Code, January 2020.
<https://cercind.gov.in/2020/reports/Final%20Report%20dated%2014.1.2020.pdf>

¹¹ The median is a better choice as the FRC value is susceptible to a small number of extreme values, or outliers. These outliers are possible when incorrect information regarding the exact quantum of load/generation lost in the control area is received for an FRC event.



RLDCs to NLDC for all the relevant control areas. An offline all India compilation in Excel/DB may be maintained by NLDC for all the control areas. While calculating ACE, this quarterly data has to be updated/refreshed every 4 seconds.

5. Measurement of Metering Errors - OFFSET

Typically, the accuracy level of the SCADA Remote Terminal Unit (RTU) is 0.5%. Also, there is a chance of error in the instrumentation and communication. Inherent latency and non-simultaneous reporting of SCADA might also cause metering error. Hence, while calculating ACE using the RTU metered tie-line flows, there is a probability of metering errors corrupting the actual value. OFFSET shall be used if such a metering error has been established using long-term data/statistical analysis.

In case of un-observable tie-line flows, where it is not feasible to replace the actual tie line flow data manually, OFFSET can be used to substitute the tie-line flow with correct sign convention. Information of manual interventions shall be monitored, carried forward and updated frequently in every shift. Sign convention adopted for interchange MW values is, positive value for export and negative value for import. While calculating ACE, OFFSET data has to be updated/refreshed every 4 seconds.

6. Calculation of ACE

Scheduled Interchange (I_s), Actual Interchange (I_a), Actual Frequency (F_a), Scheduled Frequency (F_s), Frequency Bias (B_f) and Offset shall be updated/refreshed every 4 seconds in the calculation. The formula, techniques and details have already been mentioned in the earlier sections. With the above data, ACE may be calculated every 4 seconds, i.e., refresh the value of ACE every 4 seconds.

7. Archival of different parameters

It is important to archive the individual parts of the ACE into a database every 4 seconds. That means, apart from the calculated ACE, Interchange deviation ($I_a - I_s$), Frequency deviation ($F_a - F_s$), Frequency Bias (B_f) and Offset shall also be separately archived in the database every 4 seconds. This is necessary to build and calculate what-if scenarios for reserve estimation, forecasting, etc.

8. Monitoring of ACE and Suggested Corrective Actions

All the control rooms of the control areas shall prominently monitor ACE, apart from the tie-line deviation and frequency deviation.



ACE is positive means that the control area has surplus generation and the control area's internal generation has to be backed down. ACE is negative means the control area is in deficit and the control area's internal generation has to be increased. All the frequency control interventions shall be in the direction to drive ACE towards zero. ACE remaining in the same direction for several minutes without crossing zero is a strong indicator that the frequency control interventions have to be kicked in.

9. Calculating ACE for Regional Entity Control Area

Each Regional entity power station is a control area by itself. ACE for a regional entity power plant can also be worked out separately for the purpose of monitoring. The bias would depend on the number of units on bar (40% of capacity on bar per Hz assuming 5% droop plus a small load response from the unit auxiliaries). When there are fragmented control areas and virtual power plants operated from a single control center, this aspect assumes importance.



Annexure –VII: Standard Operation Guidelines for Power Plants under AGC

Operations Guideline for Coal Based Power Plants under AGC

Revision 2, Issued: 22 September 2021

This document provides the standard operating procedures to be followed during the continuous operation of the power plants under Automatic Generation Control (AGC) and attempts to answer the frequently asked questions.

Revision History

Rev-0 : Original document – 08 July 2021

Rev-1: Formula elaborated at FAQ-4.6 Performance Calculation. Improved the document format – 20 July 2021

Rev-2: Added sections 2.6. and 2.7. Changes made in sections 2.1., 2.2., 2.4. Modified to facilitate synchronization and planned outage of generating units. Modified to facilitate partial units going into 'AGC Local' in a power plant during PG tests, etc. Added FAQ-4.9 & 4.10 – 22 Sep 2021.



1. Controls Available with the Power Plant during AGC

User data entry of the below parameters is available for all the power plants under AGC. This data is received directly by NLDC from the power plants. Data can be entered through the relevant field in the user interface of the Remote Terminal Unit (RTU) or Digital Control System (DCS). These below five signals are the “controls” available with the power plant during AGC operation.

1.1. Unit Load Set Point (ULSP) or the Base Point in MW

It is the unit-wise manual entry done by the plant shift engineer/operator in the digital control system (DCS) of the generating unit. ULSP is an ex-generating unit value entered by the power plant shift engineer in the DCS for each time block calculated by adding auxiliary power consumption of the unit to the ex-bus schedule provided by the RLDC. Note that the ex-bus schedule is provided for the total power plant by the RLDC; this is distributed in between the on bar generating units by the plant operator considering on-site constraints. To be entered for each individual unit.

1.2. Cap_Max in MW

It is the ex-generating unit capability to be updated by the power plant operator by distributing the ex-bus declared capability amongst the on-bar generating units and adding the respective auxiliary consumption. This shall be entered by the power plant operator in the DCS / HMI. To be entered for each individual unit.

1.3. Cap_Min in MW

It is the minimum limit to be entered by the power plant operator in the DCS / HMI. To be entered for each individual unit.

Note: Cap_Max and Cap_Min values summed up for the total plant are used by the AGC software at NLDC to limit the final AGC Set Point before sending to the power plant. Cap_Max and Cap_Min are manually entered values (as decided during the October 2019 meetings with thermal power plants).

1.4. Distribution Factor

It is the fraction by which the power plant operator divides the AGC regulation signal ($\Delta P = \text{Plant AGC Set Point} - \text{Plant ULSP}$) in between the generating units. This signal is available in the user interface of the AGC remote terminal unit (RTU). The sum of all distribution factors of generating units in a power plant must be 1 (this feature can be automated or kept as manual entry).

1.5. AGC Local/Remote

The manual choice to take the unit into local or remote is with the power plant shift engineer through DCS. A suitable user interface has been developed by the instrumentation team at every power plant for taking units into Local/Remote. This is a single-point digital signal (0 – Local, 1- Remote). “Remote” means unit ΔP shall be added to ULSP before processing the signal for maximum and minimum limits and further sending it to master control. Thus, if a



unit is in Remote, it is ready to accept and respond to AGC signals. "Local" means unit Delta P shall not be added to ULSP. This choice can be because of onsite problems, non-readiness to accept AGC signals, prolonged communication failure, etc.

2. Activity list for different use cases

All the above five controls have to be used to run AGC during continuous operation. Below are the typical use cases/scenarios and action items during the same.

2.1. To take a generating unit into Remote

- a. Make Distribution Factor = 0 for the units which are in Local.
- b. Make Cap_Max = Cap_Min=ULSP for the units which are in Local.
- c. Make ULSP = Cap_Max = Cap_Min = Distribution Factor =0, for all the off-bar units.
- d. Make sure to distribute Distribution Factor on the units under Remote. Ensure that the sum is 1.
- e. Check if Cap_Max and Cap_Min are entered as desired.
- f. Exchange code with NLDC. Maintain separate AGC codebook.
- g. Always ensure that the ULSP value is in between Cap_Max and Cap_Min.

2.2.To take a generating unit into Local

- a. Exchange code with NLDC (codebook format in Annexure-I). Maintain separate AGC code book.
 - If the reason is a planned one, inform in advance
 - If the reason is emergency, inform post facto
 - If the reason is automatic local, then inform post facto
- b. Make Distribution Factor = 0 for the units which are in Local.
- c. Make Cap_Max = Cap_Min=ULSP for the units which are in Local.
- d. Make sure to re-distribute Distribution Factor on the remaining units under Remote. Ensure that the sum is 1.

2.3.When a generating unit trips or is taken under shutdown, and the unit has been under Remote

- a. Exchange code with NLDC for taking the unit into Local.
 - If the reason is a planned one, inform in advance
 - If the reason is emergency, inform post facto
- b. Make Distribution Factor=0 for units which are in Local. Make sure to re-distribute Distribution Factor on the remaining units under Remote. Ensure that the sum is 1. For example, if the DF is 0.2 each for 5 units under Remote, and the fifth unit tripped, then DF will be 0 for the fifth unit and will be 0.25 for the remaining four units.
- c. Make Cap_Max=0 for the tripped unit
- d. Make Cap_Min=0 for the tripped unit
- e. Make ULSP=0 for the tripped unit



- f. Make sure that the CB status is being telemetered correctly as "Open =1"

2.4. There are three generating units; the first unit is off bar (RSD), the second unit is in Remote, and the third unit is in Local (for PG tests)

- a. Distribution Factor = 0 for first and third units
- b. Distribution Factor = 1 for second unit
- c. Make Cap_Max=0 for off bar unit (only for first unit)
- d. Make Cap_Min=0 for off bar unit (only for first unit)
- e. Make ULSP = 0 for off bar unit (only for first unit)
- f. Make Cap_Max = Cap_Min=USLP, for the units which are in Local (only for third unit).
- g. Must telemeter Cap_Max, Cap_Min, and ULSP for the second and third units

2.5. What to do after detecting Communication Failure / Communication Fluctuation.

- a. Inform NLDC for follow-up. Note that communication is provided by a third party (CTUIL/PGCIL) and not NLDC.
- b. Observe that DeltaP automatically becomes zero
- c. In case communication failure persists and/fluctuating, exchange code with NLDC and take units into Local.
- d. After communication disruption is verified as rectified, then exchange code with NLDC and take units into Remote.

2.6. How to synchronize a new unit, while other units are running under AGC Remote in a power plant?

- a. Before starting the unit
 - i. Force CB status to "Open", for that unit.
 - ii. Force Cap_Max = Cap_Min = ULSP = Distribution Factor = 0, for that unit.
- b. Start the unit and synchronize the unit. Maintain CB status as forced to "Open=1".
- c. After the unit has reached technical minimum
 - i. Make Cap_Max = Cap_Min = ULSP. Release CB status to "Closed=2".
 - ii. To take this unit into Remote, follow section 2.1, as usual.

2.7. How to take a unit under planned outage, while other units are running under AGC Remote in a power plant?

- a. Before ramping down the unit for planned outage,
 - i. Force CB status to "Open=1", for that unit.
 - ii. Force Cap_Max = Cap_Min = ULSP = Distribution Factor = 0, for that unit.
 - iii. Make sure to re-distribute Distribution Factor on the remaining units under Remote.
- b. Exchange code with NLDC for taking the selected unit into Local.



- c. Ramp down the unit and take the unit into outage.

Important Notes

1. Power plants shall not place any limits on DeltaP per unit at their end. Note that imposing any limits on DeltaP will adversely impact power plant performance metrics during post-dispatch evaluation. Restriction on DeltaP can also cause ramp violations during ULSP changes by the power plant.
2. Power plants may change Cap_Max only during periods when there is a change in conditions leading to derating or reduction in Declared Capability like tripping of coal mills, etc.
3. Power plants may change Cap_Min only during periods when there is a change in conditions leading to unstable operation at Technical Minimum or similar cases.
4. If any special limits other than Cap_Max or Cap_Min have to be placed by the power plants or if the power plant is unable to change Cap_Max or Cap_Min from their end, the same can be conveyed to NLDC over code exchange. NLDC shall honour the new max or min limits.
5. Always ensure that the ULSP value is in between Cap_Max and Cap_Min.



Operations Guideline for Gas Based Power Plants under AGC

Revision 0, Issued: 22 September 2021

This document provides the standard operating procedures to be followed during the continuous operation of the power plants under Automatic Generation Control (AGC) and attempts to answer the frequently asked questions.

Revision History

Rev-0 : Original document – 22 Sept 2021

Draft

1. Controls Available with the Power Plant during AGC

GT refers to the Gas Turbine and ST refers to the Steam Turbine. It is important to note that in the combined cycle power plants, AGC controls only the GTs. STs can operate in tandem to the GTs in combined cycle operation. The MWh generated by both GTs and STs will be compensated.

User data entry of the below parameters is available for all the power plants under AGC. This data is received directly by NLDC from the power plants. Data can be entered through the relevant field in the user interface of the Remote Terminal Unit (RTU) or Digital Control System (DCS). These below five signals are the "controls" available with the power plant during AGC operation.

1.1. Unit Load Set Point (ULSP) or the Base Point in MW

It is the unit-wise manual entry done by the plant shift engineer/operator in the digital control system (DCS) of the GT(s). ULSP is an ex-generating unit value entered by the power plant shift engineer in the DCS for each time block calculated by adding auxiliary power consumption of the unit to the ex-bus schedule provided by the RLDC. Note that the ex-bus schedule is provided for the total power plant by the RLDC; this is distributed in between the on bar generating units by the plant operator considering on-site constraints. To be entered for each individual unit.

1.2. Cap_Max in MW

It is the ex-generating unit capability to be updated by the power plant operator by distributing the ex-bus declared capability amongst the on-bar generating units and adding the respective auxiliary consumption. This shall be entered by the power plant operator in the DCS / HMI. To be entered for each GT.

1.3. Cap_Min in MW

It is the minimum limit to be entered by the power plant operator in the DCS / HMI. To be entered for each individual GT.

Note: Cap_Max and Cap_Min values summed up for the total plant are used by the AGC software at NLDC to limit the final AGC Set Point before sending to the power plant. Cap_Max and Cap_Min are manually entered values (as decided during the October 2019 meetings with thermal power plants).

1.4. Distribution Factor

It is the fraction by which the power plant operator divides the AGC regulation signal ($\Delta P = \text{Plant AGC Set Point} - \text{Plant ULSP}$) in between the GTs. This signal is available in the user interface of the AGC remote terminal unit (RTU). The sum of all distribution factors of generating units in a power plant must be 1 (this feature can be automated or kept as manual entry).

1.5. AGC Local/Remote

The manual choice to take the unit into local or remote is with the power plant shift engineer through DCS. A suitable user interface has been developed by the instrumentation team at

every power plant for taking units into Local/Remote. This is a single-point digital signal (0 – Local, 1- Remote). “Remote” means unit Delta P shall be added to ULSP before processing the signal for maximum and minimum limits and further sending it to master control. Thus, if a unit is in Remote, it is ready to accept and respond to AGC signals. “Local” means unit Delta P shall not be added to ULSP. This choice can be because of onsite problems, non-readiness to accept AGC signals, prolonged communication failure, etc.

1.6 Scaling Factor

It is the fraction (manual entry) by which the power plant can scale down the AGC DeltaP signal during combined cycle operation. For example, if 100 MW is the DeltaP signal for the plant, and scaling factor is 67%, 67 MW can be produced by all the GTs (and 33 MW is left to be produced by the STs). It is designed to be equal to ratio of the desired total GT output to the total (GT+ST) output. **Note:** Considering practical advantage of immediate delivery of power by the GTs (output from STs is usually associated with a delay), **this scaling factor shall be input as 1**, i.e., no scaling down of AGC DeltaP given to GT is needed. The excess energy delivered by ST would also be accounted for weekly.

1.7. Cycle Status

This signal is for flagging NLDC that CCGT is running under combined cycle. Manual entry. When under combined cycle, make **Cycle Status =1**, else zero. This data is used in the automatic accounting system at NLDC for accounting ST contribution.

2. Activity list for different use cases

All the above seven controls have to be used to run AGC during continuous operation. Below are the typical use cases/scenarios and action items during the same.

2.1. To take a generating unit into Remote (Open Cycle)

- h. Make Distribution Factor = 0 for the GTs which are in Local.
- i. Make Cap_Max = Cap_Min= ULSP for the GTs which are in Local.
- j. Make ULSP = Cap_Max = Cap_Min = Distribution Factor =0, for all the off-bar GTs.
- k. Distribute the Distribution Factor on the GTs under Remote. Ensure that the sum is 1.
- l. Check if Cap_Max and Cap_Min have been entered as desired for the GTs which need to be under Remote.
- m. Exchange code with NLDC. Maintain separate AGC codebook.
- n. Always ensure that the ULSP value is in between Cap_Max and Cap_Min.

2.2.To take a generating unit into Remote (Combined Cycle)

- a. Make Distribution Factor = 0 for the GTs which are in Local.
- b. Make Cap_Max = Cap_Min= ULSP for the GTs which are in Local.



- c. Make $ULSP = Cap_Max = Cap_Min = \text{Distribution Factor} = 0$, for all the off-bar GTs.
- d. Distribute the Distribution Factor on the GTs under Remote. Ensure that the sum is 1.
- e. Make Scaling Factor = 1.
- f. Make Cycle Status = 1. (This is for flagging NLDC that CCGT is running under combined cycle)
- g. Check if Cap_Max and Cap_Min are entered as desired.
- h. Exchange code with NLDC. Maintain separate AGC codebook.
- i. Always ensure that the ULSP value is in between Cap_Max and Cap_Min .

2.3.To take a generating unit into Local (Open Cycle / Combined Cycle)

- e. Exchange code with NLDC (codebook format in Annexure-I). Maintain separate AGC code book.
 - If the reason is a planned one, inform in advance
 - If the reason is emergency, inform post facto
 - If the reason is automatic local, then inform post facto
- f. Make Distribution Factor = 0 for the units which are in Local.
- g. Make $Cap_Max = Cap_Min = ULSP$ for the units which are in Local.
- h. Make sure to re-distribute Distribution Factor on the remaining units under Remote. Ensure that the sum is 1.

2.4.When a generating unit trips or is taken under shutdown, and the unit has been under Remote

- d. Exchange code with NLDC for taking the GT into Local.
 - If the reason is a planned one, inform in advance
 - If the reason is emergency, inform post facto
- g. Make Distribution Factor=0 for GTs which are in Local. Make sure to re-distribute Distribution Factor on the remaining units under Remote. Ensure that the sum is 1. For example, if the DF is 0.25 each for 4 units under Remote, and the fourth unit tripped, then DF will be 0 for the fourth unit and will be 0.33 for the remaining three units.
- h. Make $Cap_Max=0$ for the tripped unit
- i. Make $Cap_Min=0$ for the tripped unit
- j. Make $ULSP=0$ for the tripped unit
- k. Make sure that the CB status is being telemetered correctly as "Open =1"

2.5.There are three generating units; the first unit is off bar (RSD), the second unit is in Remote, and the third unit is in Local (for PG tests)

- h. Distribution Factor = 0 for first and third units
- i. Distribution Factor = 1 for second unit
- j. Make $Cap_Max=0$ for off bar unit (only for first unit)
- k. Make $Cap_Min=0$ for off bar unit (only for first unit)
- l. Make $ULSP = 0$ for off bar unit (only for first unit)



- m. Make $Cap_Max = Cap_Min = ULSP$, for the units which are in Local (only for third unit).
- n. Must telemeter Cap_Max , Cap_Min , and $ULSP$ for the second and third units

2.6. What to do after detecting Communication Failure / Communication Fluctuation.

- e. Inform NLDC for follow-up. Note that communication is provided by a third party (CTUIL/PGCIL) and not NLDC.
- f. Observe that ΔP automatically becomes zero
- g. In case communication failure persists and/fluctuating, exchange code with NLDC and take units into Local.
- h. After communication disruption is verified as rectified, then exchange code with NLDC and take units into Remote.

2.7. How to synchronize a new unit, while other units are running under AGC Remote in a power plant?

- a. Before starting the unit
 - i. Force CB status to "Open", for that unit.
 - ii. Force $Cap_Max = Cap_Min = ULSP = Distribution\ Factor = 0$, for that unit.
- b. Start the unit and synchronize the unit. Maintain CB status as forced to "Open=1".
- c. After the unit has reached technical minimum
 - i. Make $Cap_Max = Cap_Min = ULSP$. Release CB status to "Closed=2".
 - ii. To take this unit into Remote, follow section 2.1, as usual.

2.8. How to take a unit under planned outage, while other units are running under AGC Remote in a power plant?

- a. Before ramping down the unit for planned outage,
 - i. Force CB status to "Open=1", for that unit.
 - ii. Force $Cap_Max = Cap_Min = ULSP = Distribution\ Factor = 0$, for that unit.
 - iii. Make sure to re-distribute Distribution Factor on the remaining units under Remote.
- e. Exchange code with NLDC for taking the selected unit into Local.
- f. Ramp down the unit and take the unit into outage.

3. Important Notes

1. **Power plants shall not place any limits on DeltaP per unit at their end.** Note that imposing any limits on DeltaP will adversely impact power plant performance metrics during post-dispatch evaluation. Restriction on DeltaP can also cause ramp violations during ULSP changes by the power plant.
2. Power plants may change Cap_Max only during periods when there is a change in conditions leading to derating or reduction in Declared Capability like tripping of coal mills, ambient temperature fluctuation etc.
3. Power plants may change Cap_Min only during periods when there is a change in conditions leading to unstable operation at Technical Minimum or similar cases.
4. If any special limits other than Cap_Max or Cap_Min have to be placed by the power plants or if the power plant is unable to change Cap_Max or Cap_Min from their end, the same can be conveyed to NLDC over code exchange. NLDC shall honour the new max or min limits.
5. Always ensure that the ULSP value is in between Cap_Max and Cap_Min.



Operations Guideline for Hydro Power Plants under AGC

Revision 0, Issued: 08 Oct 2021

This document provides the standard operating procedures to be followed during the continuous operation of the power plants under Automatic Generation Control (AGC) and attempts to answer the frequently asked questions.

Revision History

Rev-0: Original document – 30 Sep 2021

Draft



1. Controls Available with the Power Plant during AGC

User data entry of the below parameters is available for all the power plants under AGC. This data is received directly by NLDC from the power plants. Data can be entered through the relevant field in the user interface of the Remote Terminal Unit (RTU) or Digital Control System (DCS). These below seven signals are the “controls” available with the power plant during AGC operation.

1.1. Unit Load Set Point (ULSP) or the Base Point in MW

It is the unit-wise manual entry done by the plant shift engineer/operator in the digital control system (DCS) of the generating unit. ULSP is an ex-generating unit value entered by the power plant shift engineer in the DCS for each time block calculated by adding auxiliary power consumption of the unit to the ex-bus schedule provided by the RLDC. Note that the ex-bus schedule is provided for the total power plant by the RLDC; this is distributed in between the on bar generating units by the plant operator considering on-site constraints. To be entered for each individual unit.

1.2.P1 in MW

It is the minimum value after synchronization to be entered by the plant operator in the DCS/HMI. To be entered for each individual unit.

1.3.P2 - P3 in MW (Forbidden zones or high cavitation zones)

P2 – P3 is the forbidden zone / cavitation zone for all the Francis turbine based hydro power plants entered by the power plant operator in the DCS/HMI. To be entered for each individual unit.

1.4.P4 in MW

It is the MW value up to which a unit can be overloaded. To be entered by the plant operator in the DCS/HMI for each individual unit.

1.5.Cap_Max in MW

It is the ex-generating unit capability to be updated by the power plant operator by distributing the ex-bus declared capability amongst the on-bar generating units and adding the respective auxiliary consumption. This shall be entered by the power plant operator in the DCS / HMI. To be entered for each individual unit.

1.6. Cap_Min in MW

It is the minimum limit to be entered by the power plant operator in the DCS / HMI. To be entered for each individual unit

1.7.AGC Local/Remote

The manual choice to take the unit into local or remote is with the power plant shift engineer through DCS. A suitable user interface has been developed by the instrumentation team at every power plant for taking units into Local/Remote. This is a single-point digital signal (0 – Local, 1- Remote). “Remote” means unit Delta P shall be added to ULSP before processing the



signal for maximum and minimum limits and further sending it to master control. Thus, if a unit is in Remote, it is ready to accept and respond to AGC signals. "Local" means unit Delta P shall not be added to ULSP. This choice can be because of onsite problems, non-readiness to accept AGC signals, prolonged communication failure, etc.

2. Activity list for different use cases

All the above five controls have to be used to run AGC during continuous operation. Below are the typical use cases/scenarios and action items during the same.

2.1. To take a generating unit into Remote

- o. Check if P1, P2, P3 and P4 are entered as desired.
- p. Inform NLDC if any other limit has to be imposed (e.g. to operate between P3 and P4, during high hydro season).
- q. Exchange code with NLDC. Maintain separate AGC codebook.
- r. Always ensure that the ULSP value is in between P1 and P4.

2.2. To take a generating unit into Local

- i. Exchange code with NLDC. Maintain separate AGC code book.
 - If the reason is a planned one, inform in advance
 - If the reason is emergency, inform post facto
 - If the reason is automatic local, then inform post facto

2.3. What to do after detecting Communication Failure / Communication Fluctuation?

- i. Inform NLDC for follow-up. Note that communication is provided by a third party (CTUIL/PGCIL) and not NLDC.
- j. Observe that DeltaP automatically becomes zero
- k. In case communication failure persists and/fluctuating, exchange code with NLDC and take units into Local.
- l. After communication disruption is verified as rectified, then exchange code with NLDC and take units into Remote.

2.4 What to do if the AGC Setpoint is remaining in the forbidden zone?

1. Check if the forbidden zones (P2 and P3) telemetered to NLDC are correct.
2. Check if the communication between plant and NLDC is healthy. If not, take units into local immediately and exchange code with NLDC.
3. Check if the DeltaP has become zero after communication failure.
 - If DeltaP has not become zero, investigate why.
 - Sometimes the delay time can be 20-30 seconds for detecting communication break. Wait and check again.
 - Check if the setter feedback to NLDC is telemetered correctly and without delay (a delay of 2-4 seconds is acceptable).
 - o. Check AGC Setpoint and setter feedback signal to observe delay.



4. If setter feedback and communication both are healthy, inform NLDC to check the settings at their end.

3. Important Notes

1. **Power plants shall not place any limits on DeltaP per unit at their end.** Note that imposing any limits on DeltaP will adversely impact power plant performance metrics during post-dispatch evaluation. Restriction on DeltaP can also cause ramp violations during ULSP changes by the power plant.
2. Power plants may change P4 only during periods when there is a change in conditions leading to derating or reduction in Declared Capability, low water gross head, etc.
3. Power plants may change P1 only during periods when there is a change in conditions leading to unstable operation at P1 value or similar cases.
4. If any special limits other than P4 or P1 have to be placed by the power plants or if the power plant is unable to change P4 or P1 from their end, the same can be conveyed to NLDC over code exchange. NLDC shall honour the new P4 or P1 limits.

Sample format for providing information to NLDC

The AGC operation status for date-DD/MM/YY of the Power Stations are as below

SI No	Name of Power Station	Unit Capacity (MW)	Operational Range	Reason
1	Plant-A	180	P3 to P4	Spillage
2	Plant-B	100	P3 to P4	Spillage
3	Plant-C	77	IC to P4	Spillage
4	Plant-D	170	IC to P4 for 02 units	Spillage & heavy trash
5	Plant-E	35	No AGC	Silt Flushing
6	Plant-F	70	IC to P4	Spillage
7	Plant-G	130	IC to P4	Spillage

5. Always ensure that the ULSP value is in between P1 and P4.



Annexure -VIII: Guidelines for operating intra-state generators/entities under AGC from NLDC

1. Intra-state generators shall submit the application to NLDC through appropriate RLDC for participating in SRAS through AGC.
2. Intra-state generators shall obtain standing consent (as per format SRAS-3) from respective SLDCs before participating in SRAS through AGC. SLDC shall ensure that proper scheduling, measurement (through SCADA), metering (through Special Energy Meters), accounting and settlement is in place before issuing consent to the concerned intra-state generator.
3. Intra-state generators shall ensure end-to-end communication in compliance to section 6 of this document.
4. Intra-state generators shall ensure the availability of appropriate hardware after checking the eligibility criterion as per section 5 of this document and Annexure-IV.
5. Intra-state generators shall provide the signals in compliance with section-7 of this document and Annexure-V of this document.
6. Intra-state generators shall provide the details as per format SRAS-1, including variable charge / compensation charges.
7. Intra-state generators that would be connected to NLDC would be given the AGC Set Point using Regional Area Control Error (ACE). Detailed methodology of ACE calculation is given in Annexure-VI. For example, any intra-state generator in Uttar Pradesh that would be connected to NLDC after completing s.no.1 to s.no.6, would be given the AGC Set Point using the Northern Regional Area Control Error (ACE).
8. Standard Operating Procedure mentioned in Annexure-VII shall be applicable for intra-state generators also.
9. NLDC shall share the real-time AGC data of the intra-state generators through ICCP to RLDCs, and RLDCs shall share the same with the respective SLDCs.
10. In the case of intra-state generators participating in SRAS, Nodal Agency shall share the weekly SRAS 5-minute MWh and 15-minute MWh ex-bus quantum to the respective RLDC for onward transmission to the respective



SLDCs.

11. The respective SLDCs shall maintain the relevant scheduling data of intra-state entities during the SRAS operation (including but not limited to generating station-wise installed capacity, declared capacity, schedule, Un-Requisitioned Surplus (URS), generator wise SRAS schedules for up/down and requisitions from the generating stations).
12. SLDCs shall use the real time AGC MW data obtained through ICCP from the RLDCs, and incorporate it to the state's net schedule for the purpose of monitoring deviations.
13. AGC DeltaP quantum for intra-state generators shall be incorporated in state's net schedule (with appropriate sign) for the purpose of computation of deviations by SLDC or appropriate agency in the state. Hence, generation of the intra-state generator under AGC would not be considered as deviation of the state.
14. SLDCs shall use the 15-minute SRAS MWh quantum data received from RLDC for deviation settlement.
15. **Weekly Accounts:** Weekly account data (5-minute MWh data and 15-minute MWh data) shall be shared by the intra-state generators through SLDCs to Nodal Agency in the format that would be provided after connection request. Section 17 of this document would be followed for weekly energy accounting.
16. **Accounting & Settlement:** For the intra-state generators, energy generated under AGC would be compensated through the Regional DSA Pool Account as per section 17 and section 18 of this document. For the intra-state generators, the settlement of payments towards SRAS-Up/SRAS-Down 15-minute MWh along with the performance based incentive would be done by the RPC with the respective Regional Deviation and Ancillary Service Pool Account.

Annexure -IX: Detailed Methodology for Performance Assessment and Data Filtering

Good performance of the power plants under AGC is essential for effective frequency control. When the power plant is in Remote, the Actual MW should follow AGC Set Point for best performance. Performance metric is measured by plotting Output versus Input. CB status and Local/Remote status signals are considered in the calculations, so when the plant is in Local or not on bar, the performance is not evaluated.

$$\text{For 'n' units, Output} = \sum_{i=1}^n ((\text{Actual MW}_i - \text{ULSP}_i - \text{Governor MW}_i) * \text{CB}_i * \text{LR}_i)$$

$$\text{Input} = \sum_{i=1}^n ((\text{Delta P}_i) * \text{CB}_i * \text{LR}_i)$$

Then a scatter plot of Output vs Input is prepared similar to as shown below. A trend line (to fit $Y=mX$) to the plot is added. The data set is 5-minute data for a sample week. In the below figure, the ideal expectation would be $y=x$; output response is the same as the input command.

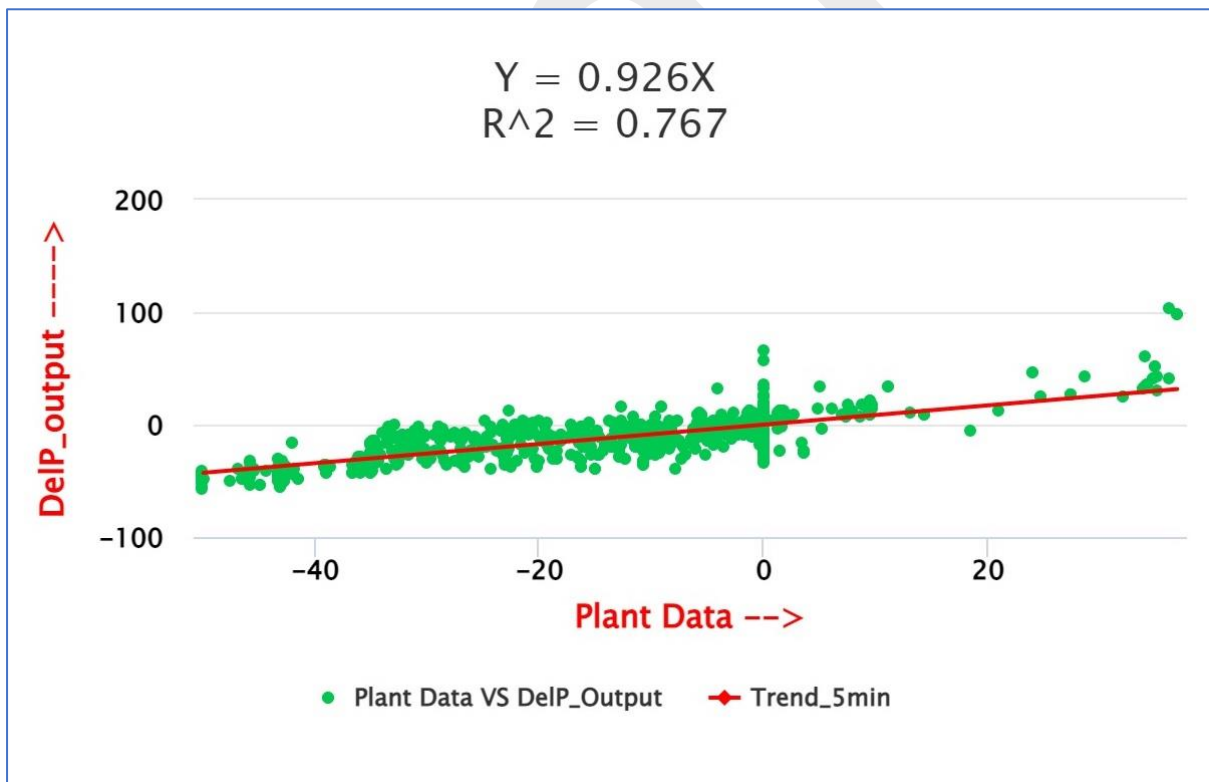

Figure-1: Sample performance of a plant under AGC for a week

As this process has to be carried out every week, sufficient automation has been custom built around the AGC software and historian for the retrieval and processing of data. As a result, there would be minimal or no manual intervention while carrying out these calculations.

Filtering Output MW data through Normal Distribution

The Output MW data is derived from Actual MW, ULSP and RGMO MW, which are all telemetered SCADA signals and may contain some noise. The below simple method would be used for filtering the Gross Output MW data while calculating the performance of the power plants under AGC.

1. Convert the raw 4s MW data to 5 min average MW data using the historian and scripts
2. Collect the 5 min average MW data into MS Excel files
3. Read the gross output MW 5 min average MW data into NoSQL database
4. Read the gross output data into array and create a copy
5. Calculate the Mean and Standard Deviation (σ) of the data of gross output MW
6. Calculate
 - a. (Mean-3*Standard Deviation)
 - b. (Mean+3*Standard Deviation)
7. If the raw copy data \geq 6.a. and raw copy data \leq 6.b., then don't change the data. Else replace the raw copy data with the implemented schedule plant data.

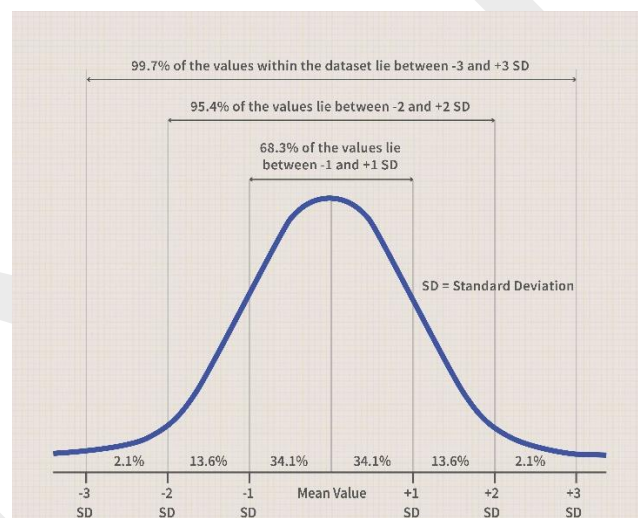
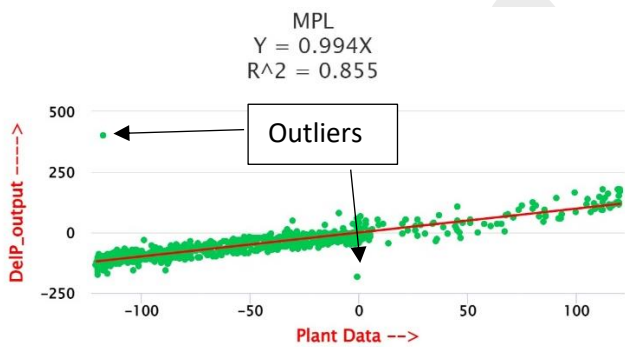
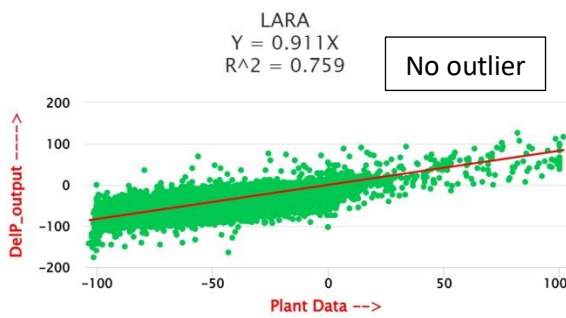
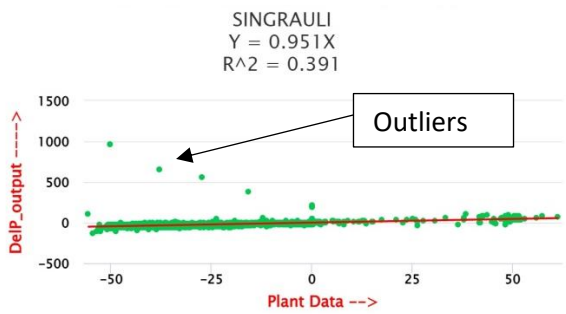

Figure 2: Normal Distribution

8. Because of the above procedure, 99.7% values remain unchanged. The 0.3 % of the outliers in the SCADA data would be replaced with the implemented schedule input data, thereby improving the confidence level of the linear trend line. The resulting data may show either a higher, lower or the same performance, varying on a case-to-case basis. Examples of power plant performance before after this data filtering is given below.

Before filtering



After filtering

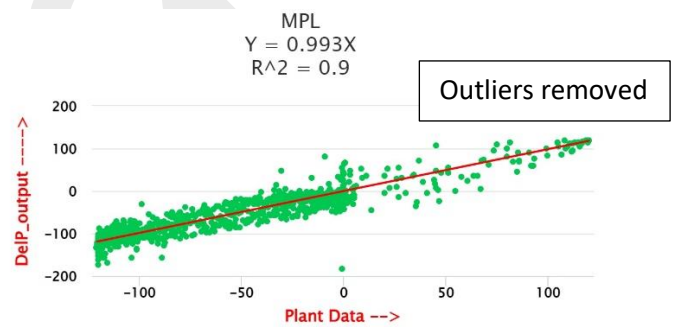
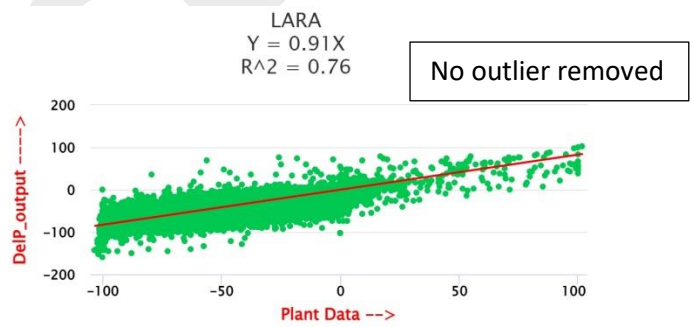
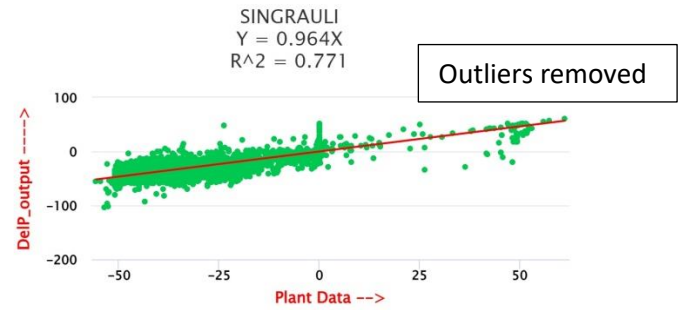



Annexure -X: Undertaking on Cyber Security

UNDERTAKING ON CYBER SECURITY I, _____ (Name of Plant I/c) on behalf of _____ (Organisation Name), hereby declare that

- a) I hereby unconditionally accept and ensure all the cyber security measures at plant end which are mentioned in the subsequent points
- i) Only authorised equipment (AGC, computer (HMI) and Router-cum firewall) required for AGC functioning will be connected.
 - ii) Internet access is blocked in the computer used for AGC HMI and Antivirus is installed and patches will be updated regularly in the HMI computer.
 - iii) No Internet interface will be provided in the network used for the AGC purpose.
 - iv) Router cum firewall will be dedicatedly used for communication with NLDC AGC system.
 - v) RTU remote access cable will be connected only for absolutely essential works and will be disconnected after work.
 - vi) All the ports other than 2404 are blocked in the router-cum-firewall.
 - vii) All the IPs other than IPs provided by NLDC are blocked in the firewall.
 - viii) DCS is not connected with any IT equipment.
 - ix) Application whitelisting at AGC server & HMI shall be implemented with alerts feature in case of any unwanted application.
 - x) Checks shall be performed by IT experts regularly at power plants for tracing any unwanted processes.
- b) We will comply with all the applicable/prevaling statutory provisions, laws, acts and Government orders amended/notified during the period of AGC operation.
- c) We have disclosed all the information related to connectivity of equipments within AGC network and information so provided is true, correct, complete and nothing has been concealed thereof.
- d) We understand that, in situation of non-compliance of cyber security measures and incorrect/false declaration, the present integration of plant will be disconnected from AGC network by POSOCO without any prior information.

Dated:

Place:

Yours Faithfully,

Signature: _____

Name:

Contact:

Address:

Format SRAS-3: Standing Consent by SLDC to Intra-State SRAS Provider

Ref.No.

Dated

1. Name of SLDC issuing Standing Consent:
2. Region: NR / WR/ SR/ ER/ NER:
3. Entity seeking consent from SLDC to become an Secondary Reserve Ancillary Services (SRAS) Provider:
4. Status of Entity (CPP/IPP/State Power Plant/DISCOM, etc.):
5. Point(s) of connection:
6. Validity Period (From date and To date):

Declaration:

The intra-state generator shall fulfill the below conditions:

- I. Scheduling, measurement (through SCADA), metering (through Special Energy Meters), accounting and settlement is in place for the above SRAS Provider.
- II. Intra-state SRAS Provider shall ensure end-to-end communication in compliance to the Detailed Procedure.
- III. Intra-state SRAS Provider shall ensure the availability of appropriate hardware after checking the eligibility criterion in compliance to the Detailed Procedure.
- IV. Intra-state SRAS Provider shall provide the signals in compliance to the Detailed Procedure.
- V. Intra-state generators shall provide the technical and commercial details as per the Detailed Procedure.
- VI. Standard Operating Procedure mentioned in the Detailed Procedure shall be followed at all times by the intra-state SRAS Provider.
- VII. Weekly account data (5-minute MWh data and 15-minute MWh data) shall be shared by the intra-state SRAS Provider through SLDCs to Nodal Agency in the format that would be provided after connection request.
- VIII. Any change in the contents of the Standing Consent shall be conveyed to the party to whom Standing Consent was given, within 24 hours. In such cases all the stakeholders shall be informed simultaneously.

Intra-state generating entity shall be aware that:

1. Intra-state generators that would be connected to NLDC would be given the AGC Set Point using Regional Area Control Error (ACE).
2. NLDC shall share the real-time AGC data of the intra-state generators through ICCP to RLDCs, and RLDCs shall share the same with the respective SLDCs.
3. In the case of intra-state generators participating in SRAS, Nodal Agency shall share the weekly SRAS 5-minute MWh and 15-minute MWh ex-bus quantum to the respective RLDC for onward transmission to the respective SLDCs.



4. The respective SLDCs shall maintain the relevant scheduling data of intra-state entities during the SRAS operation (including but not limited to generating station-wise installed capacity, declared capacity, schedule, Un-Requisitioned Surplus (URS), generator wise SRAS schedules for up/down and requisitions from the generating stations).
5. SLDCs shall use the real time AGC MW data obtained through ICCP from the RLDCs, and incorporate it to the state's net schedule for the purpose of monitoring deviations.
6. AGC DeltaP quantum for intra-state generators shall be incorporated in state's net schedule (with appropriate sign) for the purpose of computation of deviations by SLDC or appropriate agency in the state. Hence, generation of the intra-state generator under AGC would not be considered as deviation of the state.
7. SLDCs shall use the 15-minute SRAS MWh quantum data received from RLDC for deviation settlement.
8. Weekly Accounts: Weekly account data (5-minute MWh data and 15-minute MWh data) shall be shared by the intra-state generators through SLDCs to Nodal Agency in the format that would be provided after connection request. Section 17 of this document would be followed for weekly energy accounting.
9. Accounting & Settlement: For the intra-state generators, energy generated under AGC would be compensated through the Regional DSA Pool Account as per the Detailed Procedure. For the intra-state generators, the settlement of payments towards SRAS-Up/SRAS-Down 15-minute MWh along with the performance based incentive would be done by the RPC with the respective Regional Deviation and Ancillary Service Pool Account.

Standing Consent is hereby provided to the intra-state generator mentioned above seeking to participate in the Secondary Reserve Ancillary Services (SRAS) mechanism in accordance with the Detailed Procedure prepared in compliance to the Central Electricity Regulatory Commission (Ancillary Services) Regulations, 2022, subject to the declaration made above.

Signature:
Name:
Designation:
(Authorized Signatory)
Phone No:

Place:

Date:

Telemetry Statistics for the Month of April 2023

ANNEXURE B7

Sl. No.	Utility	Average Total Percentage	Instantaneous Maximum of Total percentage	Average Analog Percentage	Average Digital Availability	Average RTU Availability
1	PGCIL	95.77	98.33	95.39	95.96	92.13
2	NEEPCO	92.3	95.56	88.88	94.53	99.51
3	NTPC	98.24	100	98.17	98.28	98.21
4	NHPC	97.45	98.15	99.29	96.45	99.29
5	OTPC	98.77	100	98.9	98.71	98.84
6	KMTL	99.82	100	99.83	99.82	99.88
7	IndiGrid	98.46	100	97.29	98.95	99.97
8	Arunachal Pradesh	38.61	56.86	46.46	33.21	46.22
9	Assam	64.07	73.29	65.92	62.71	71.39
10	Manipur	57.01	72.22	58.33	56.22	57.96
11	Meghalaya	50.98	57.37	68.44	37.88	77.76
12	Mizoram	38.39	44.72	47.99	30.42	68.31
13	Nagaland	46.37	56.88	38.56	52.43	39.09
14	Tripura	21.22	24.91	29.33	15.43	30.57
	NER	65.01	70.36	66.39	64.1	66.23

Comparson of Telemetry Availability Statistics (Average %age)

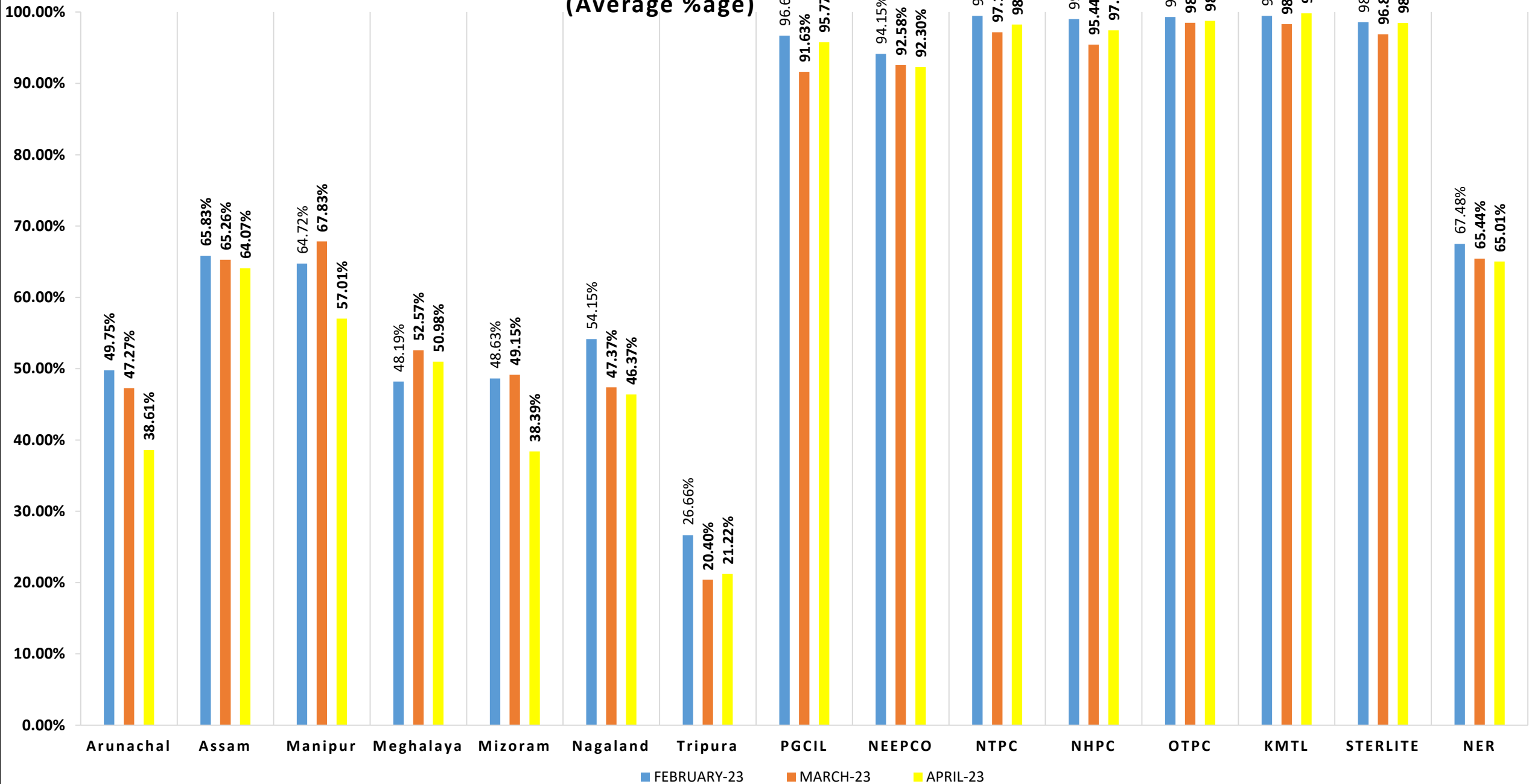

Telemetry Statistics for Central Sector of NER (Average availability of data for the Month of APRIL '23)

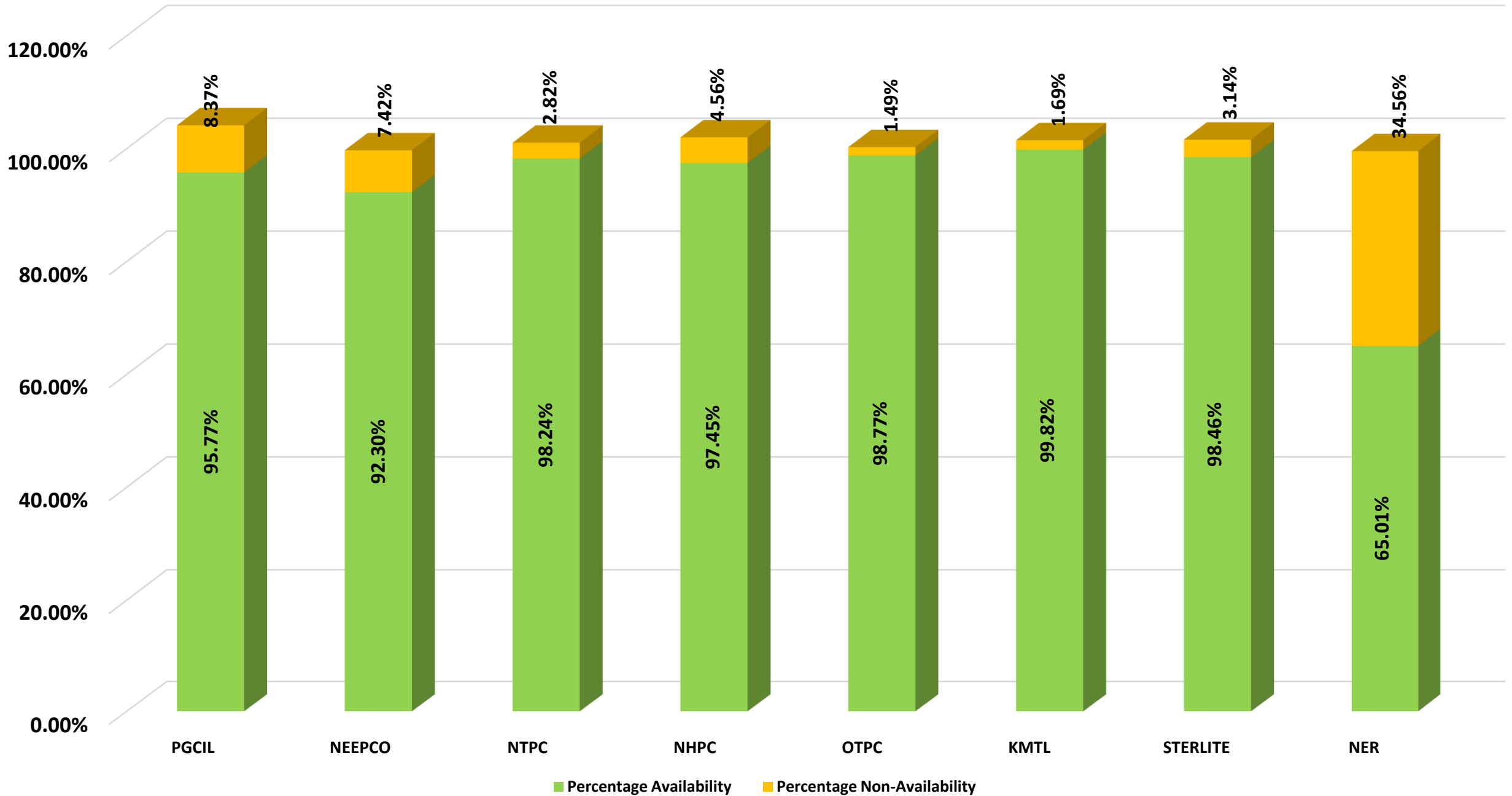

Telemetry Statistics for NER States(Average availability of data for the Month of APRIL '23)

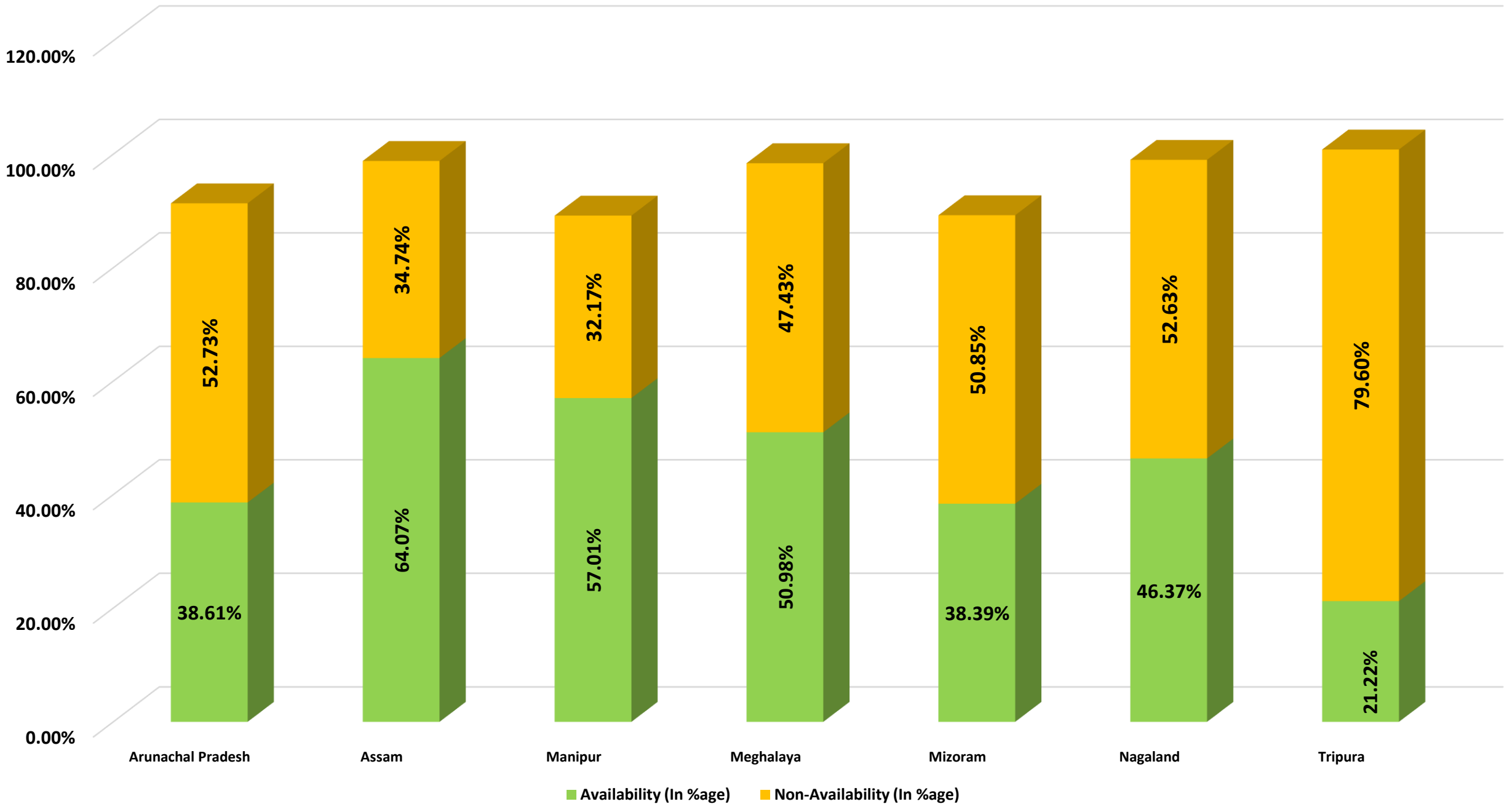

Real Time Data Availability of NER (In Percentage)

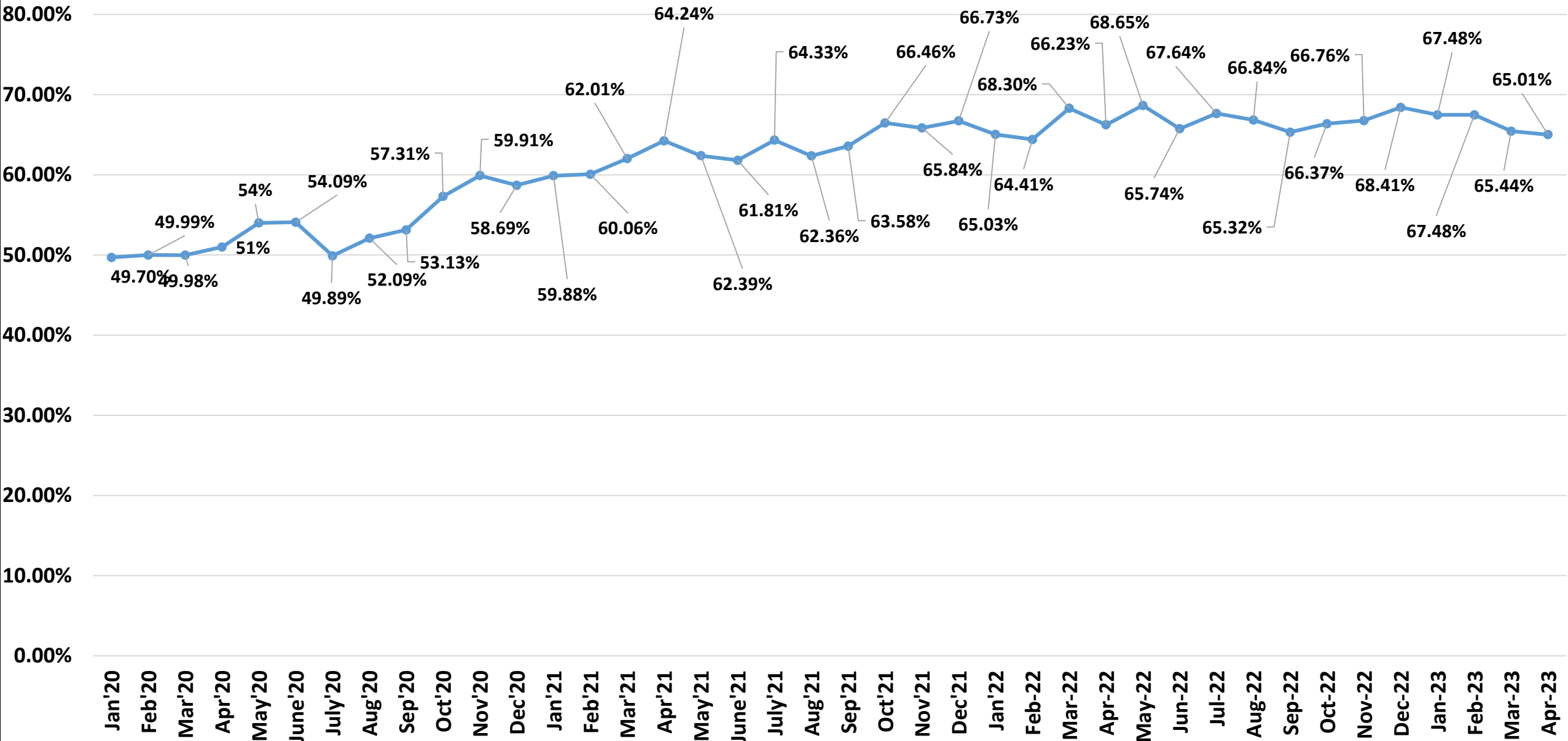

Real Time Data Availability of Assam State (In Percentage)

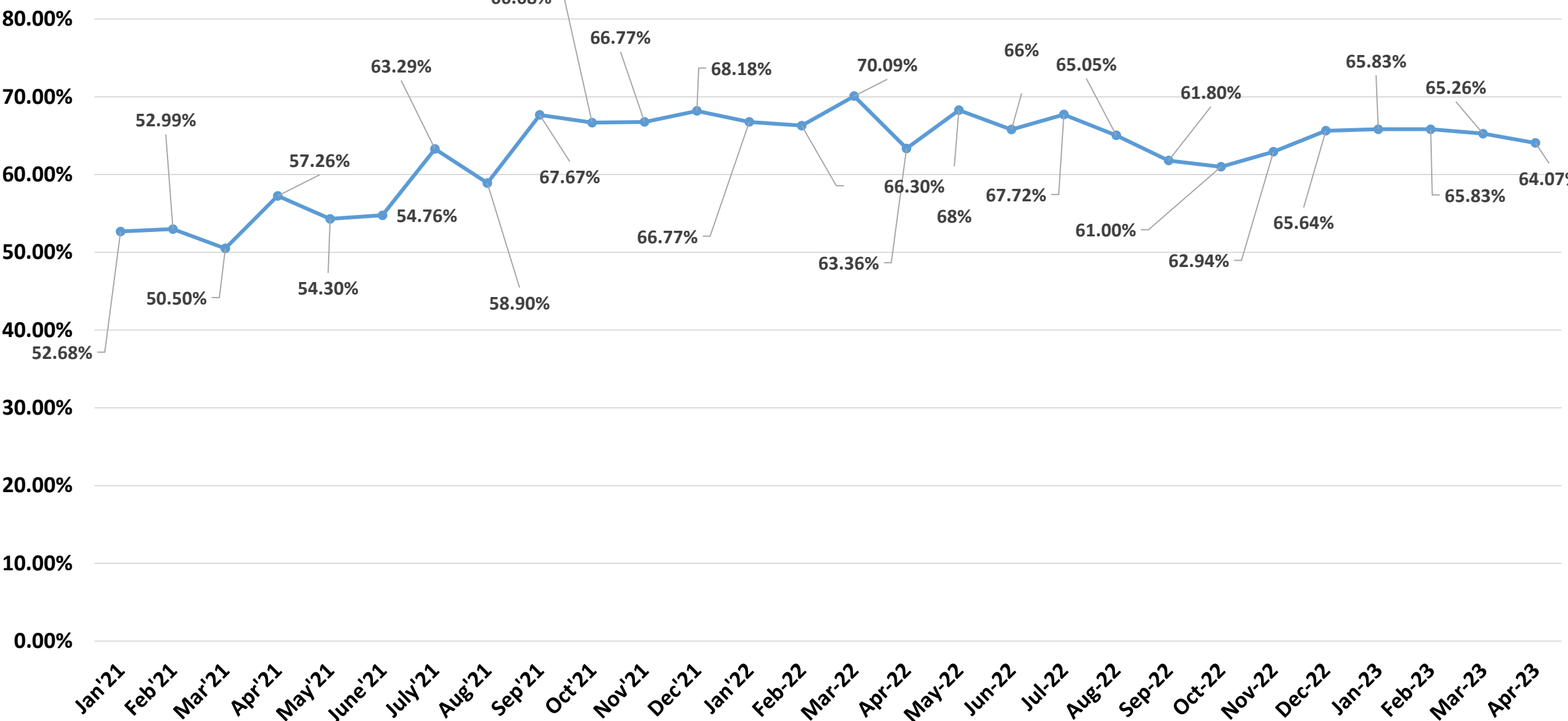

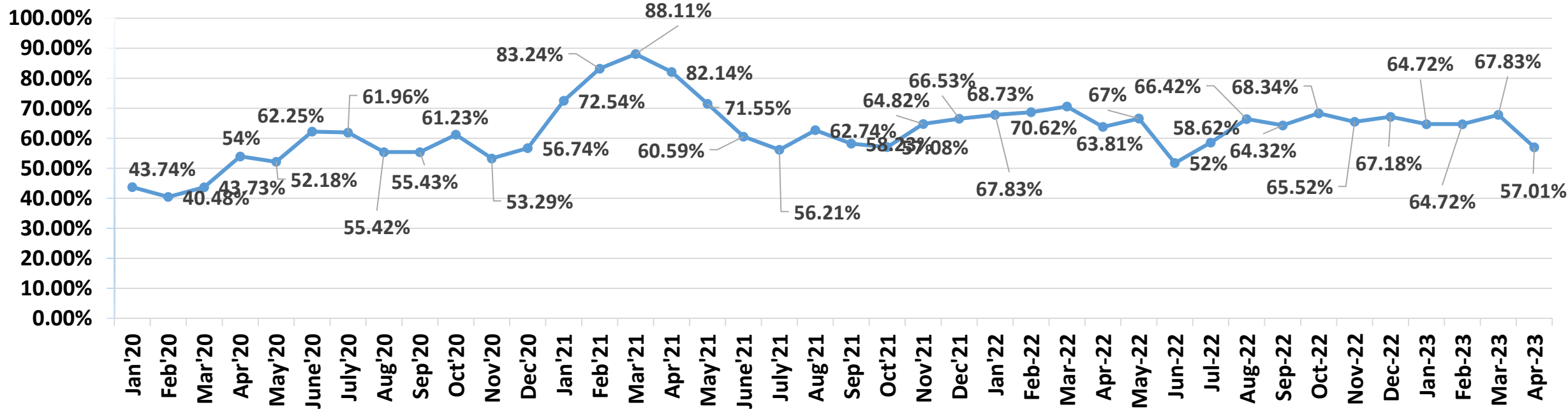

Real Time Data Availability of Meghalaya State (In Percentage)

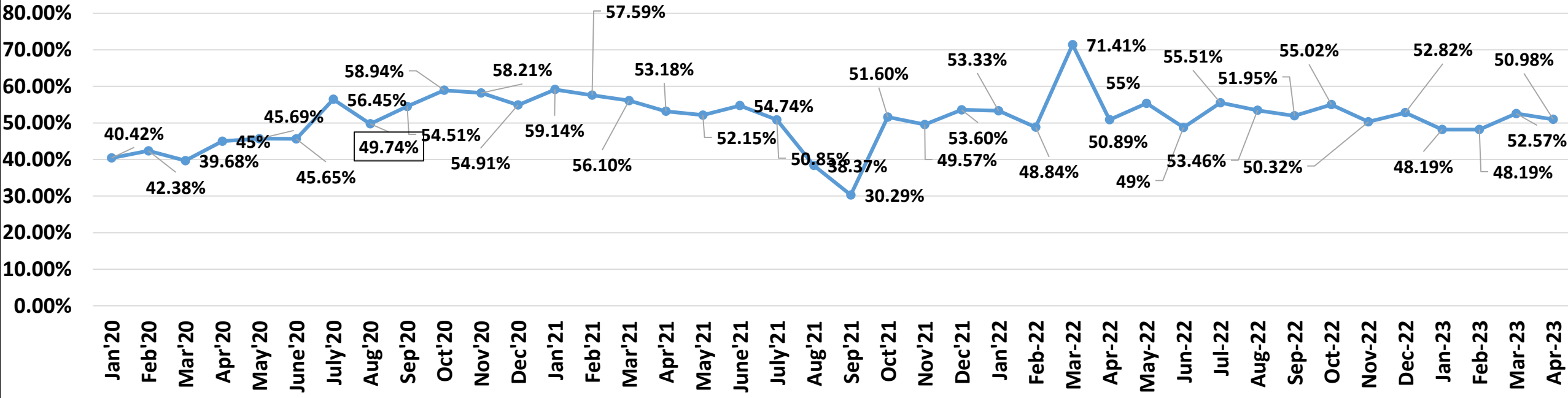

Real Time Data Availability of Tripura State (In Percentage)

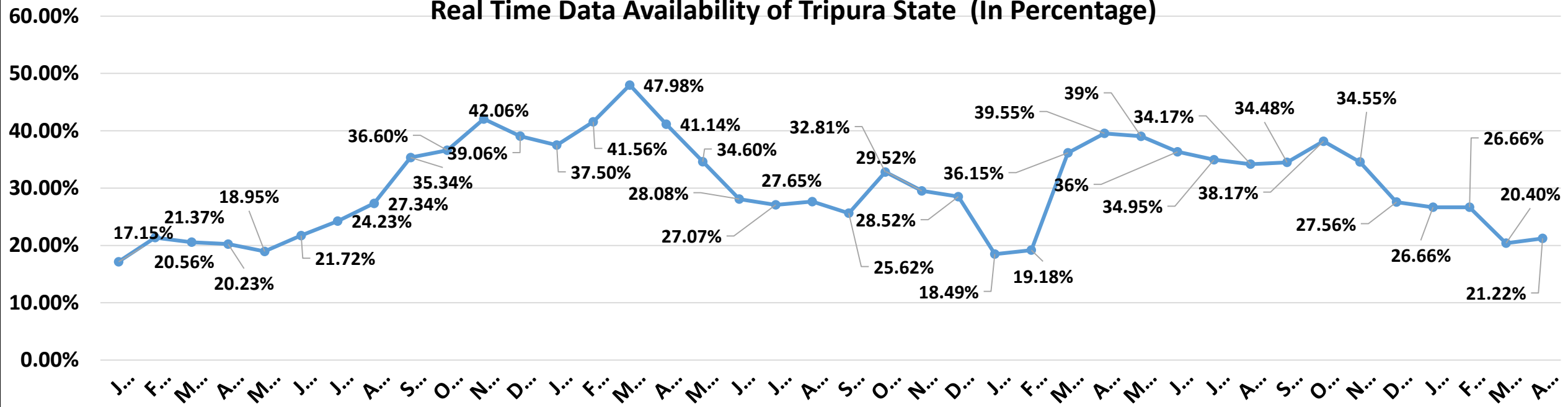

Real Time Data Availability of Arunachal Pradesh State (In Percentage)

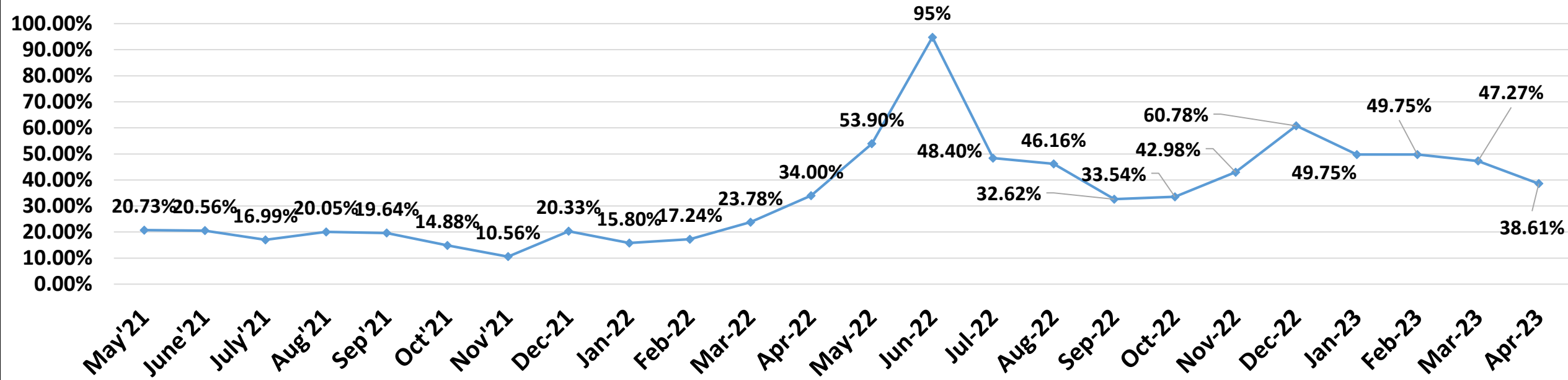

Real Time Data Availability of Nagaland State (In Percentage)

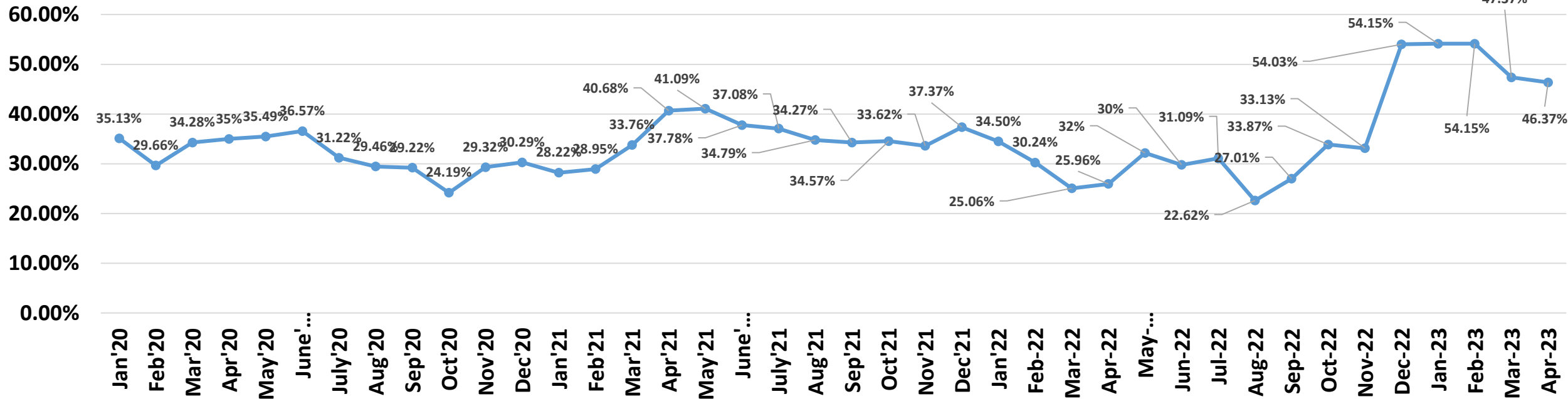

Real Time Data Availability of Mizoram State (In Percentage)

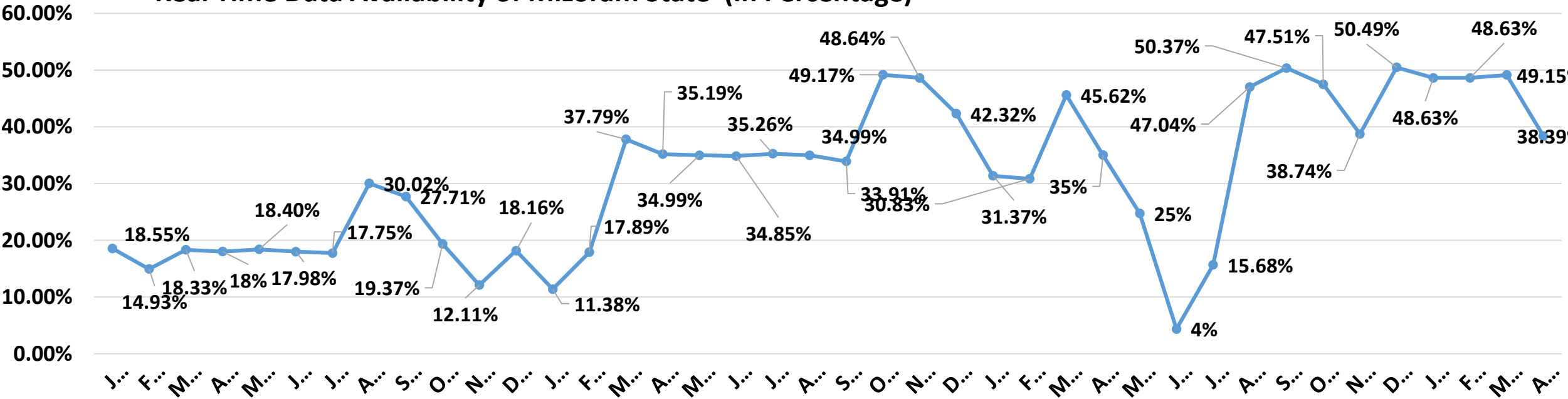

Real Time Data Availability of PGCIL (In Percentage)

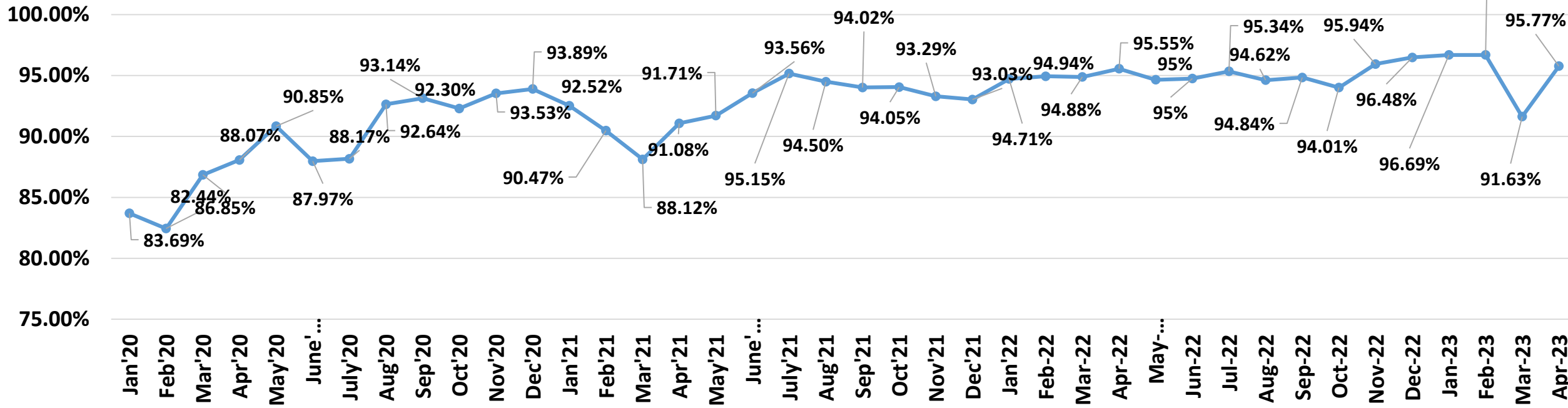

Real Time Data Availability of NEEPCO (In Percentage)

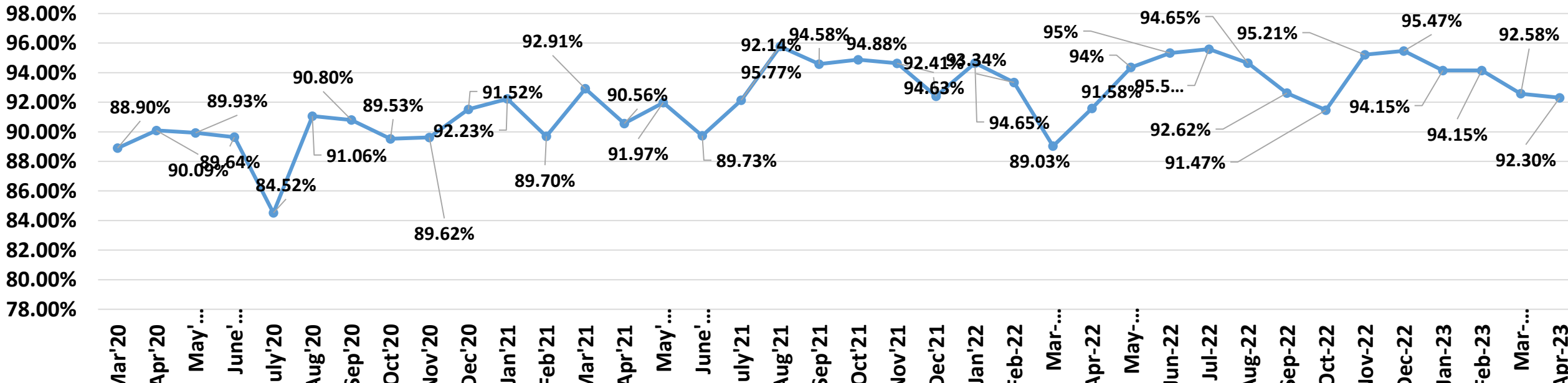

Real Time Data Availability of NTPC (In Percentage)

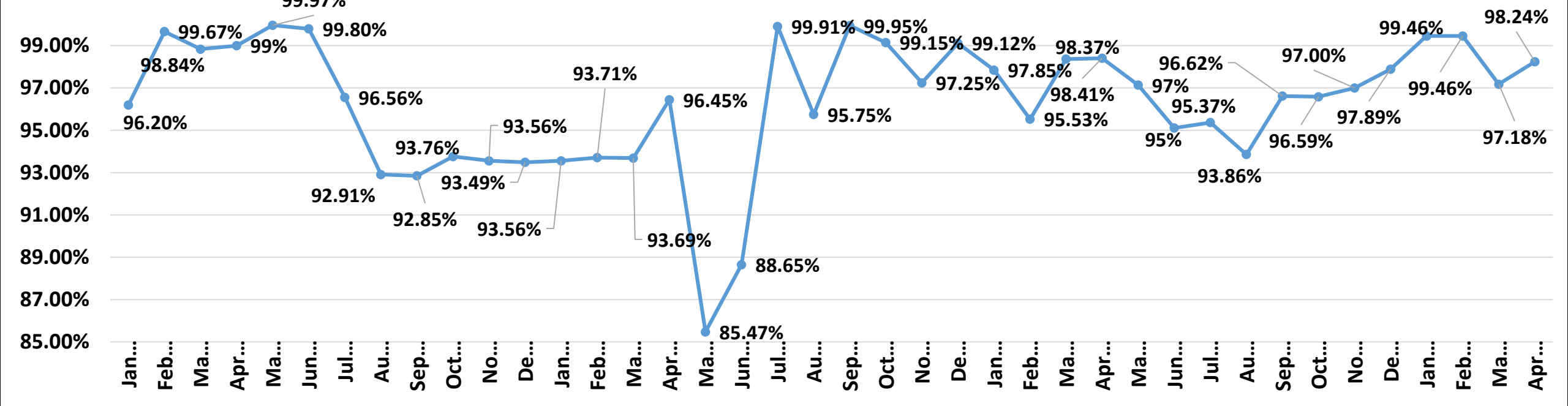

Real Time Data Availability of NHPC (In Percentage)

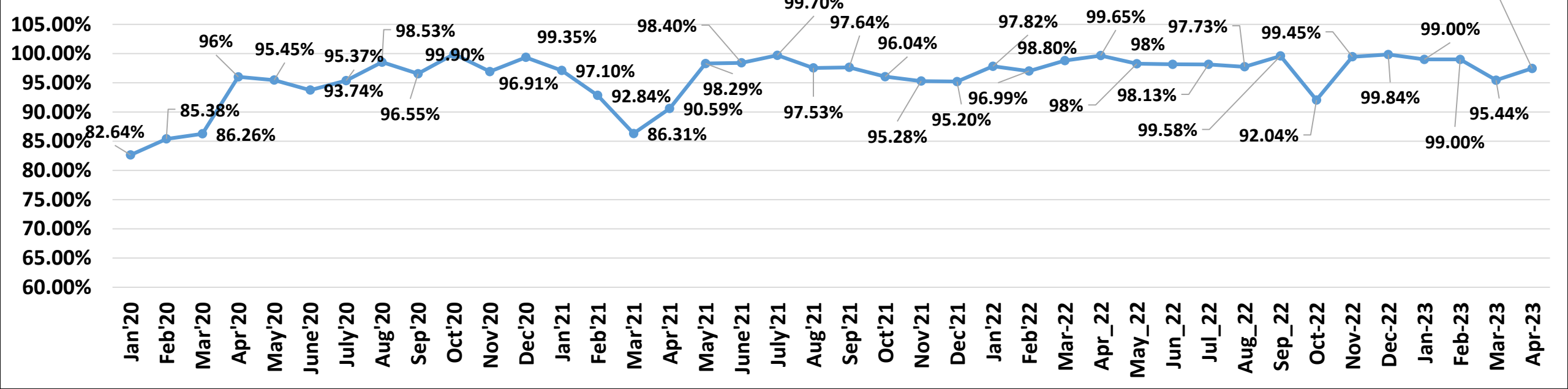

Real Time Data Availability of OTPC (In Percentage)

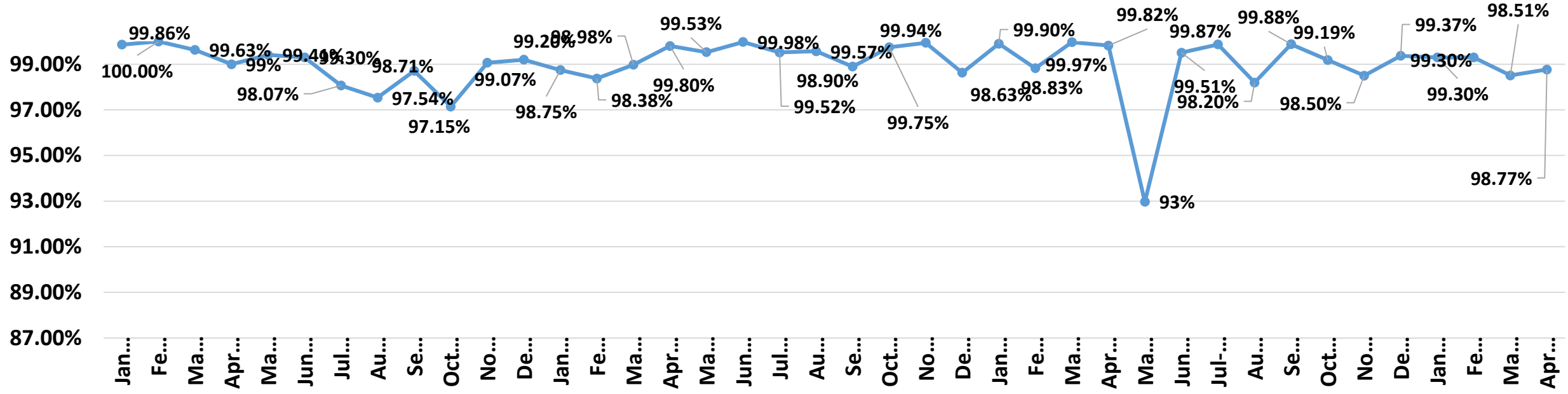

Real Time Data Availability of KMTL (In Percentage)

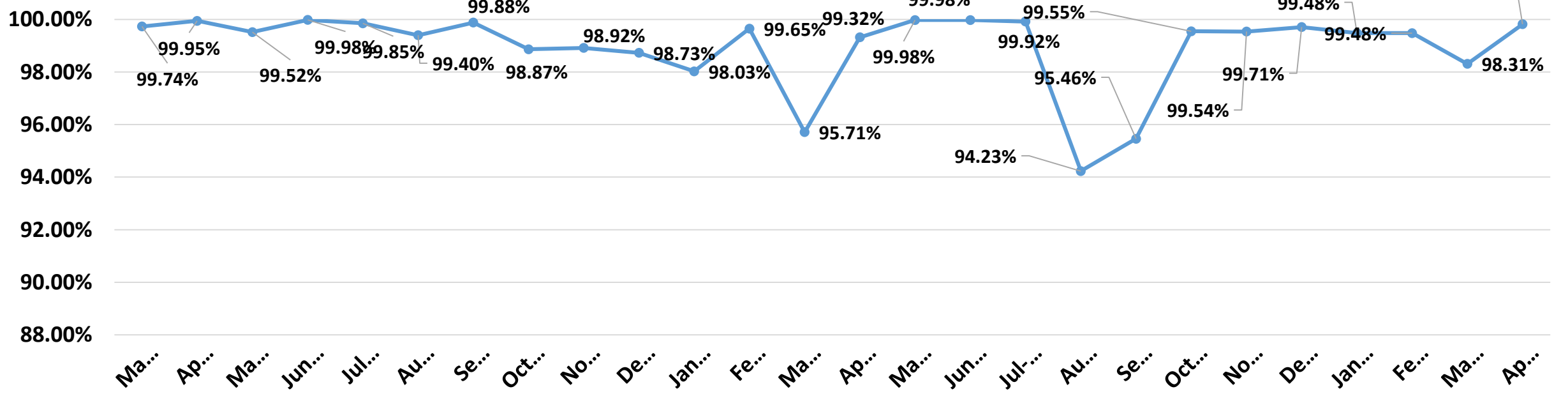

Real Time Data Availability of IndiGrid (In Percentage)

